

NANLITE

Forza 60B II
USER MANUAL

Guangdong NanGuang Photo&Video Systems Co., Ltd

Forza 60B II LED Bi-color Spot Light

■ Product Diagram

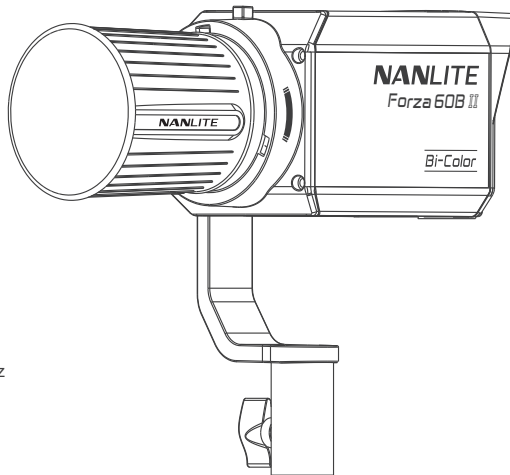

■ Technical Data

Rated Power: 72W

Input voltage/current: DC 15V/6A Max
AC100-240V 50/60Hz

Color Temperature: 2700K-6500K

CRI: Average 96

TLCI: Average 98

Product Details

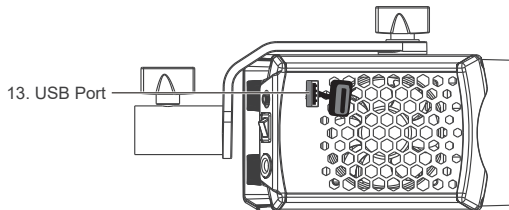
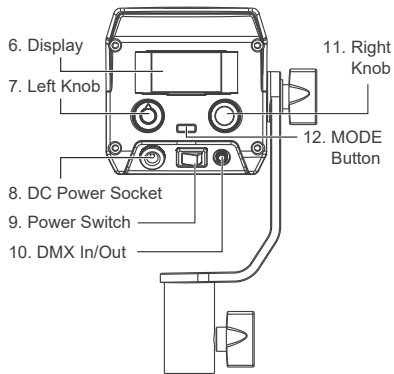
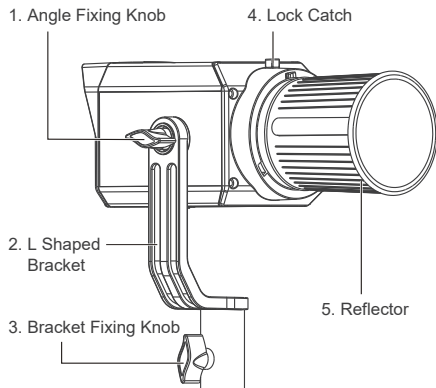

Detailed Description

1. Angle Fixing Knob: For adjusting and fixing the tilt direction of fixture.
2. L Shaped Bracket: Designed for connecting the light to the light stand and adjusting the direction of illumination.
3. Bracket Fixing Knob: For locking the light fixture on the stand, and for pan adjustment of fixture.
4. Lock Catch: To lock or release the reflector or other accessories.
5. Reflector: For concentrating light to improve the central illumination.
6. Display: For displaying various functions, operations and datas.
7. Left Knob: For adjusting the DIM and scrolling through different selections.
8. DC Power Socket: DC power input socket.
9. Power Switch: For switching on/off the fixture.
10. DMX In/Out: Connect to 1/2 DMX adapter cable for DMX signal input and output.
(Note: 1/2 DMX adapter cable is sold separately).
11. Right Knob: For selecting various functions.
12. MODE Button: For switching between CCT mode, EFFECT mode and MENU.
13. USB Port: For updating firmwares or connecting USB cable to external devices with maximum current of 5V/0.5A.

Usage

1. Installation and Detachment of Reflector

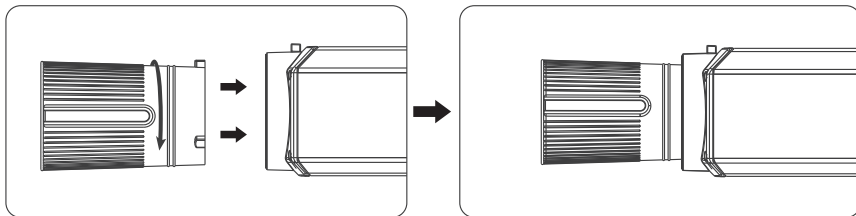

- ① When installing the reflector, align the reflector to the fixture's FM mount, rotate the reflector in the direction shown on the fixture until it clicks into place.

Note: This light is with FM mount, so please use accessories with FM mount, if the accessories with Bowens mount are needed, pls mount after installing the Bowens mount adapter.

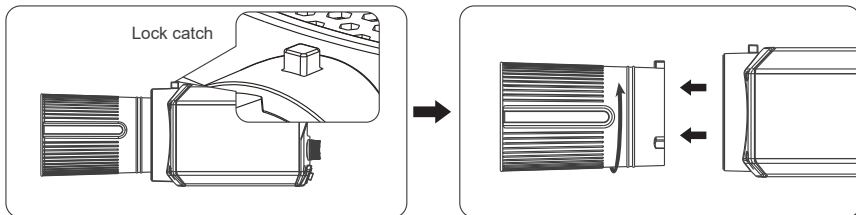

- ② When removing the reflector, push and hold the lock catch and rotate until the reflector is free to be removed from the fixture.

2. Installation and Detachment of Bowens Mount Adapter

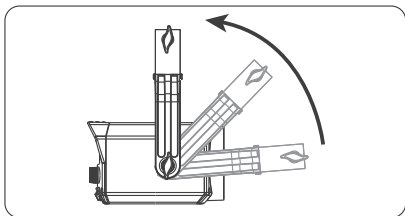

① Adjust the L shaped bracket to the top position before installation.

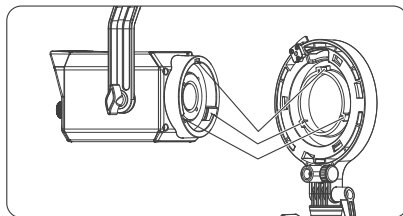

② When installing the adapter, ensure its mounting points align with the slots on the light fixture, rotate it according to the direction shown on the fixture until the adapter is put into place.

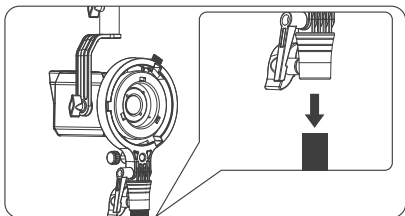

③ Mount the adapter on the light stand.

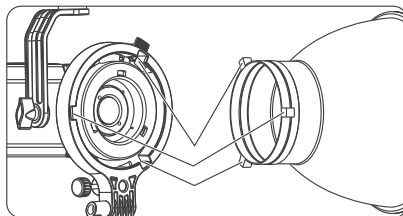

④ Ensure the Bowens mount accessories align with the slots of the Bowens mount adapter, rotate it according to the direction shown on the adapter until the accessories are put into place.

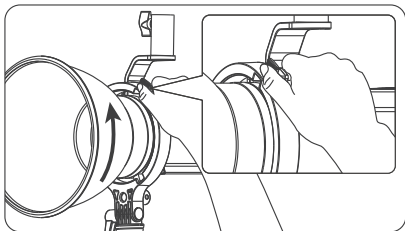

- ⑤ When removing the accessory, push and hold the release button and rotate according to the direction shown on the adapter until the accessory is free to be removed from the adapter.

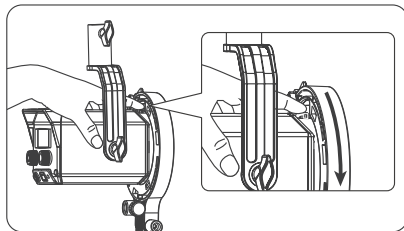

- ⑥ When removing the adapter, push and hold the release button and rotate according to the direction shown on the light until the adapter is free to be removed from the light.

3. Installation of Battery Grip

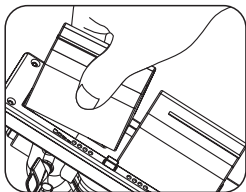

- ① Slide 2*NP-F battery onto the battery grip.

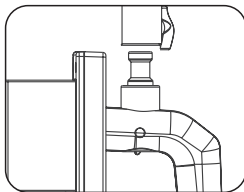

- ② Mount the light onto the receiver on the grip and lock.

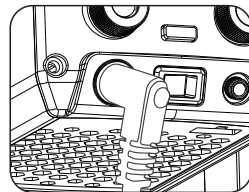

- ③ Ensure the light is switched off, connect DC plug into the DC power socket.

Remote Control

· Forza 60B II supports 2.4G remote control, DMX/RDM control, and includes a built-in Bluetooth module as well.

▲ The channel needs to be set before operating the remote control via 2.4G and DMX/RDM.

1. CHANNEL and DMX Mode Setting, including CHANNEL, DMX MODE, DMX REDUCED CHANNELS, DMX DIMMING CURVE and DMX SMOOTHING settings.

① CHANNEL Setting



Press the MODE button to enter the menu.

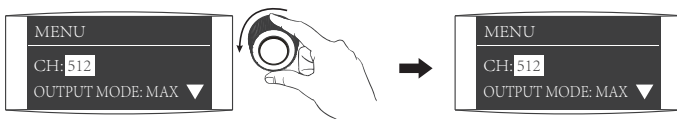

Rotate the "right knob" to CH.



Rotate the "left knob" to select the channel.

②DMX Mode Setting



Press the MODE button to enter the menu.

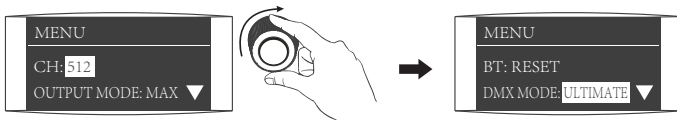

Rotate the "right knob" to DMX MODE.



Rotate the "left knob" to select CCT 8 bit or ULTIMATE.

③DMX REDUCED CHANNELS



Press the MODE button to enter the MENU.



Rotate the "right knob" to DMX REDUCED CHANNEL .



Rotate the "left knob" to select ON or OFF.

④DMX DIMMING CURVE



Press the MODE button to enter the MENU.

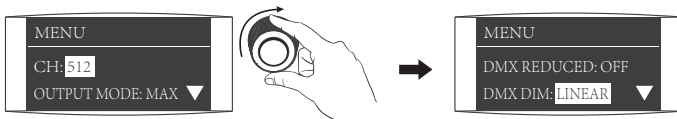

Rotate the "right knob" to DMX DIM CURVE.



Rotate the “left knob” to select LINEAR, EXPONENT, LOGARITHM, S CURVE or GAMMA 2.2.

⑤DMX SMOOTHING



Press the MODE button to enter the MENU.



Rotate the “right knob” to DMX SMOOTHING.

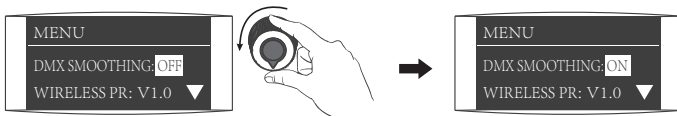

Rotate the “left knob” to select ON or OFF.

2. DMX Control

① Connect the fixture to the DMX/RDM consoles via DMX cable as shown below:



② DMX Terminator

In DMX control mode, the DMX output of the last light fixture should be connected with a DMX terminator (not included). The terminator is connected with a 120Ω(OHM) resistor across Pin 2 and Pin 3 (As shown below).

This prevents interference caused by DMX signals in the transmitting process.

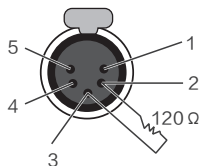

DMX Terminator Connection
Connect a 120Ω(OHM) resistor across Pin 2 and Pin 3 in an XLR plug and insert into the DMX OUT socket on the last unit.

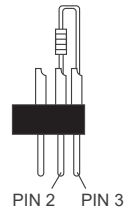

③Address Setting of the Light Fixture.

④Refer to the DMX reference guide and control the light via DMX/RDM console. (For detailed operation please refer to the DMX/RDM console operation manual.)

Note: DMX reference guide "Forza_60B II_REFERENCE_GUIDE_EN" is downloadable from www.nanlite.com.



Please scan the QR to check and download the latest DMX reference guide.

3. RDM Control

①Connect the light fixture to the console with RDM function by using a connection cable, the connection method is the same as that with a DMX/RDM console.

②Control the fixture via a console with RDM function. (For specific operation methods, please refer to the RDM console operation manual.) Note: The UID format of the fixture is as follows:

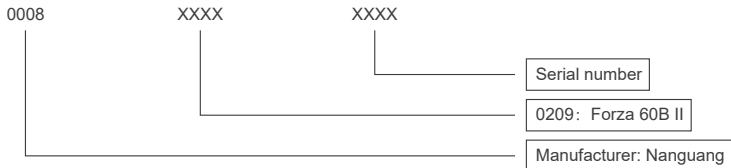

4. 2.4G Remote Control

- Forza 60B II can be remotely controlled by 2.4G remote controller and by NANLINK APP via Bluetooth directly or via the WS-TB-1 transmitter box.

Note: ①2.4G remote controller and WS-TB-1 transmitter box are sold separately.

- ②The fixture supports the 2.4G wireless protocol V1.0 and V2.0. The fixture should be set in V2.0 while using WS-RC-C1 or WS-RC-C2 remote controller, set in V1.0 while using other remote controllers.



Press MODE button to enter the menu.



Rotate the "right knob" to WIRELESS PROTOCOL.

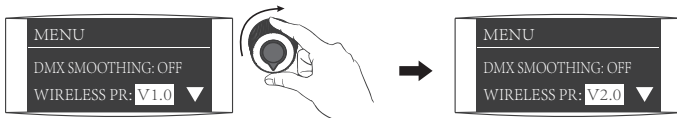

Rotate the "left knob" to select V1.0 or V2.0.

Operating Instructions

1. Connection between fixture and power adapter.

- ① First ensure that the power switch is off. Now turn on the light, the screen will display all the relevant information for the fixture.

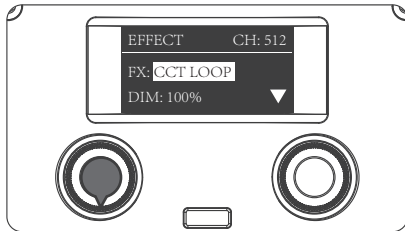
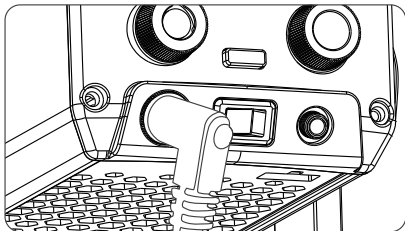
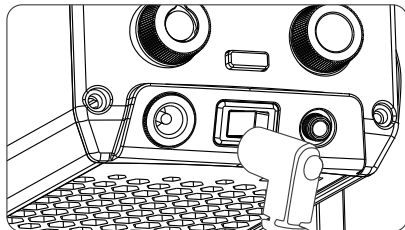
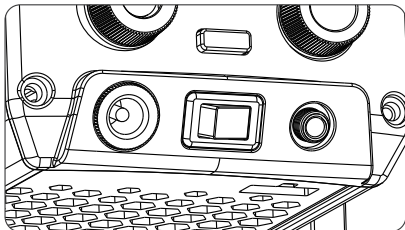

2. CCT Mode setting

Press MODE button to CCT mode, Rotate the "left knob" to adjust the DIM (DIM range: 000%...100%), rotate "right Knob" to adjust the color temperature (CCT range: 2700K...6500K)



Press MODE button to CCT mode.

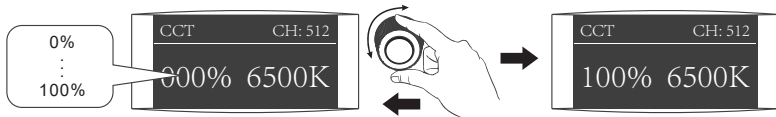

Rotate the "left knob" to adjust the DIM.

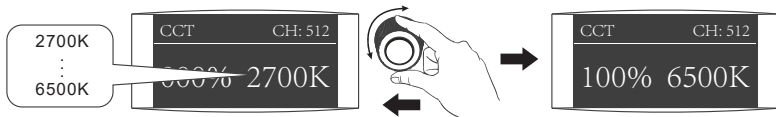

Roate "right Knob" to adjust the color temperature.

Note: ①In effect mode, DIM range is the same as the CCT MODE.

②In effect mode, the color temperature is not synchronized with the color temperature in CCT mode, and the CCT adjustment range is the same as that of in the CCT mode.

③When the fixture function is unlocked, in any mode, press the "left knob" to turn off the fixture, and the brightness percentage on the screen will be 000%. Press again to restore the fixture to its previous state. Press continuously to switch the fixture between on and off.

3. EFFECT Mode setting

Press MODE button to EFFECT mode. The Forza 60B II has built-in effects including CCT LOOP, INT LOOP, FLASH, PULSE, STORM, TV, PAPARAZZI, CANDLE/FIRE, BAD BULB, FIREWORK, EXPLOSION and WELDING.



Press MODE button to EFFECT mode.



Rotate the "right knob" to FX.

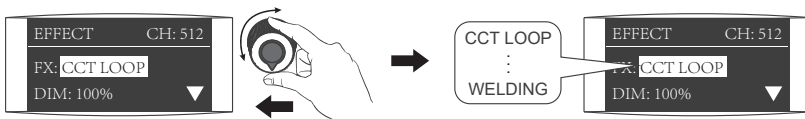

Rotate the "left knob" to select the desired effect.

① CCT LOOP

CCT LOOP setting: Rotate the "right knob" to select from DIM, CCT and SPD (Range: 02S...30S), then rotate the "left knob" to set the parameters.



Rotate the "right knob" to select from DIM, CCT and SPD.



Rotate the "left knob" to set the parameters.

② INT LOOP

INT LOOP setting: Rotate the "right knob" to select from DIM, CCT and SPD (Range: 02S...30S), then rotate the "left knob" to set the parameters.



Rotate the "right knob" to select from DIM, CCT and SPD.



Rotate the “left knob” to set the parameters.

③FLASH

FLASH setting: Rotate the “right knob” to select from DIM, CCT and INTVL (INTVL: 0.1S...10S), then rotate the “left knob” to set the parameters.



Rotate the “right knob” to select from DIM, CCT and INTERVALS.



Rotate the “left knob” to set the parameters.

④PULSE

PULSE setting: Rotate the "right knob" to select from DIM, CCT and PULSES/MIN (Range: 001...240), then rotate the "left knob" to set the parameters.



Rotate the "right knob" to select from DIM, CCT and PULSES/MIN.



Rotate the "left knob" to set the parameters.

⑤STORM

STORM setting: Rotate the "right knob" to select from DIM, CCT and INTVL (Range: 1s ... 60s) , then rotate the "left knob" to set the parameters.

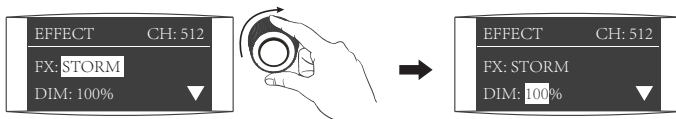

Rotate the "right knob" to select from DIM, CCT and INTVL.



Rotate the “left knob” to set the parameters.

⑥TV

TV setting: Rotate the “right knob” to select from DIM, CCT and SPD (Range: 001...100), then rotate the “left knob” to set the parameters.

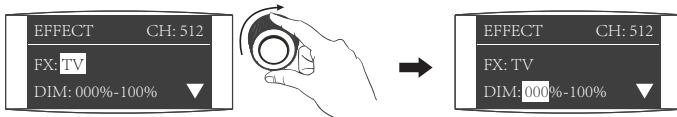

Rotate the “right knob” to select from DIM, CCT and SPD.

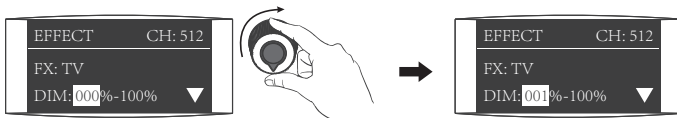

Rotate the “left knob” to set the parameters.

⑦PAPARAZZI

PAPARAZZI setting: Rotate the “right knob” to select from DIM, CCT and SPD (Range: 001...100), then rotate the “left knob” to set the parameters.

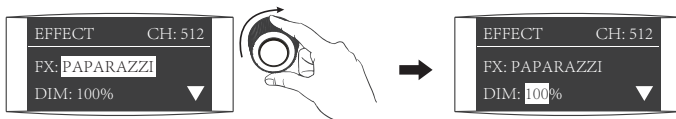

Rotate the “right knob” to select from DIM, CCT and SPD.



Rotate the “left knob” to set the parameters.

⑧CANDLE/FIRE

CANDLE/FIRE setting: Rotate the “right knob” to select from DIM, CCT and SPD (Range: 001...100), then rotate the “left knob” to set the parameters.



Rotate the “right knob” to select from DIM, CCT and SPD.



Rotate the “left knob” to set the parameters.

ⓄBAD BULB

BAD BULB setting: Rotate the “right knob” to select from DIM, CCT and SPD (Range: 001...100), then rotate the “left knob” to set the parameters.



Rotate the “right knob” to select from DIM, CCT and SPD.



Rotate the “left knob” to set the parameters.

⑩ FIREWORK

RIREWORK setting: Rotate the “right knob” to select from DIM ,CCT, SPD (Range: 001...100) and DECAY (Range: 001...100), then rotate the “left knob” to set the parameters.

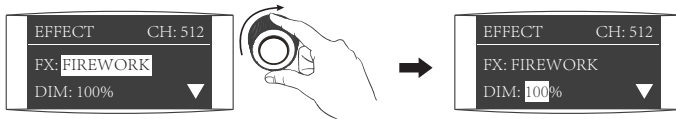

Rotate the “right knob” to select from DIM, CCT, SPD and DECAY.



Rotate the “left knob” to set the parameters.

⑪ EXPLOSION

EXPLOSION setting: Rotate the “right knob” to select from DIM, CCT, SPD (Range: 001...100) and DECAY (Range: 001...100), then rotate the “left knob” to set the parameters.

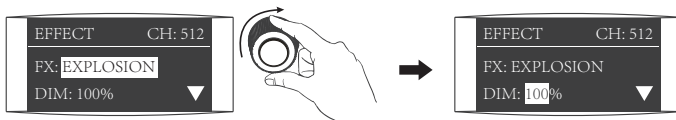

Rotate the “right knob” to select from DIM, CCT, SPD and DECAY.



Rotate the “left knob” to set the parameters.

⑫WELDING

WELDING setting: Rotate the “right knob” to select from DIM, CCT, SPD (Range: 001...100) and PAUSE (ON/OFF), then rotate the “left knob” to set the parameters.



Rotate the “right knob” to select from DIM, CCT, SPD and PAUSE.

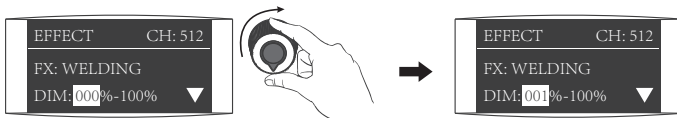

Rotate the “left knob” to set the parameters.

- Special effects may be upgraded based on the firmware update. Please refer to the latest firmware function description for reference.

4. MENU setting



Press MODE button to MENU.

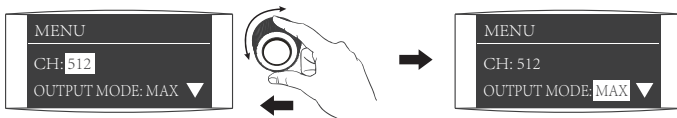

Press "right Knob" to select from CHANNEL, OUTPUT MODE, BLUETOOTH, DMX MODE, DMX REDUCED CHANNELS, DMX DIMMING CURVE, DMX SMOOTHING, WIRELESS PROTOCOL, FAN, FIRMWARE UPDATE, LANGUAGE and FIRMWARE VERSION.

①CHANNEL

For channel setting, please refer to P7 for detailed operations.

②OUTPUT MODE



Press MODE button to MENU.



Rotate the "right knob" to OUTPUT MODE.

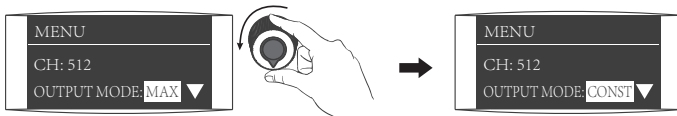

Rotate the "left knob" to select MAX or CONSTANT.

③BLUETOOTH RESET



Press MODE button to switch to the MENU.

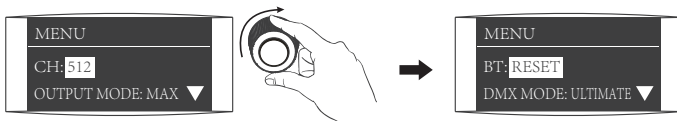

Rotate the "right knob" to BLUETOOTH.



Press the "right knob" to enter the interface of BLUETOOTH RESET.



Rotate the "right knob" to select RESET.



Press "right Knob" to confirm reset and it will return to the menu after bluetooth reset.

④DMX MODE

For DMX mode setting, please refer to P7 for detailed operations.

⑤DMX REDUCED CHANNELS

For DMX reduced channels setting, please refer to P8 for detailed operations.

⑥DMX DIMMING CURVE

For DMX dimming curve setting, please refer to P9 for detailed operations.

⑦DMX SMOOTHING

For DMX smoothing setting, please refer to P9 for detailed operations.

⑧WIRELESS PROTOCOL

For wireless protocol setting, please refer to P12 for detailed operations.

⑨FAN

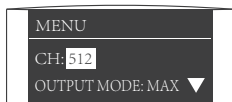

Press MODE button to MENU.

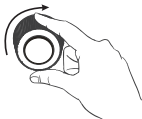
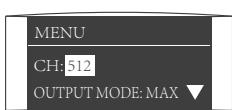

Rotate the "right knob" to FAN.



Rotate the "left knob" to select ON or OFF.

Note: (1)When the fan is turned on, the maximum output of the light will be 100%.

(2)When the fan is turned off, the maximum output of the light will be 30%.

⑩ FIRMWARE UPDATE

Insert the USB flash drive with the latest firmware into the light fixture.

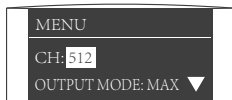

Press MODE button to MENU.

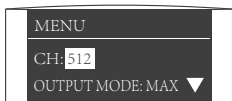

Rotate the "right knob" to FW UPDATE.



Press the "right knob" to enter the interface of FOUND FIRMWARE.



Rotate the "right knob" to select UPDATE.



Press "right Knob" to start the update, it will show "FIRMWARE UPDATED" after the firmware update is completed.

⑩ LANGUAGE



Press MODE button to MENU.



Rotate the "right knob" to LANGUAGE.



Rotate the "left knob" to select Chinese or English.

⑫VERSION



Press MODE button to MENU.

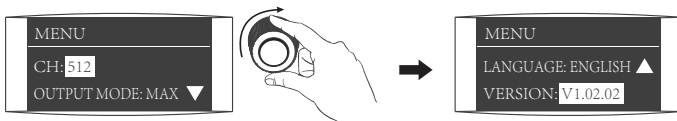

Rotate the "right knob" to VERSION to check the current firmware version.

5. Lock or Unlock Settings: long press the "right knob" to lock the light status. The current light status cannot be changed by pressing the button or rotating the knobs. Long press the "right knob" again to unlock.



Long press the "right Knob" to lock the light status.



Long press the "right Knob" again to unlock.

6. When the fixture is not in use, please turn it off.







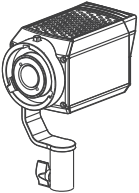
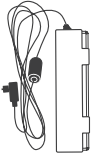

Safety Precautions

1. Please check for possible damage caused in transit after opening the package. Please do not use if damage is found. And contact with the distributor or manufacturer as soon as possible.
2. Please do not use a power cable with damaged insulation. Please do not unplug too hard or drag the power cable directly.
3. Please make sure the voltage of power supply accords with the voltage specified on the fixture before installation.
4. Please turn the fixture off when it is not in use or before cleaning.
5. Please keep the fixture safely stored and away from children.

Notice

1. Please remove the COB protective cap before using the fixture.
2. Please do not look directly at the emitter when the fixture is on .
3. Please do not place any object on the fixture or allow liquid to flow inside the fixture.
4. Please do not place the fixture near any flammable or volatile substances like alcohol or gasoline.
5. Please do not use strong detergent for cleaning. Please wipe off the dirt by using a cloth with neutral cleanser when cleaning the fixture.
6. Please set up the fixture in a dry and well-ventilated place. Please do not use it in any humid, dusty or overheated environment. Meanwhile, please also check whether the fan and vent are unimpeded.
7. Please do not disassemble the fixture at will to repair by yourself. Qualified professionals should conduct maintenance under the condition of strictly following the operating procedures described in this manual.
8. Please do not cover the vents when using, to avoid affecting heat dissipation, and resulting in damage. Please pay attention to anti-scald when using the fixture for a long time, since the surface temperature of fixture will be high.

What's in the box? Please kindly check.

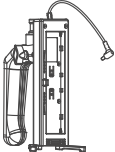
<p>Forza 60B II ×1</p> 	<p>Power Adapter ×1</p> 	<p>Power Cable 3M ×1</p> 	<p>User Manual × 1</p> 
<p>Carrying Bag ×1</p>	<p>Bowens Mount Adapter ×1</p>	<p>COB Protective Cap ×1</p>	<p>DMX Reference Guide ×1</p>
			
<p>RF-FMM-45-S Reflector ×1</p>	<p>BH-FZ60 Battery Grip × 1</p>		
			

General Fault Detection and Diagnosis

Fault Detection	Diagnosis
The light won't boot up properly	<ol style="list-style-type: none"> 1. Please check whether the connection between power supply and cable or fixture are loose. 2. Please check whether the voltage value is within the specified range. 3. If the fixture is powered by batteries, please check if the batteries are into place, whether the battery voltage/current is consistent with the specified voltage/current.
The fixture can be operated manually, but DMX control is not working.	<ol style="list-style-type: none"> 1. Please check whether the DMX address code setting of the fixture is correct. 2. Please check whether the DMX signal cable is connected correctly and without damaged.
The display screen is on, but fixture cannot be operated.	The COB or main board is damaged.
The fan doesn't work	Please check if the fan is set to OFF mode.
If the failure is not resolved after troubleshooting, please contact place of purchase.	

This manual has been compiled according to the rigorous testing of our company's products. Product designs are subject to change without prior notice. You can download the latest version of the manual for this particular product from www.nanlite.com.

Version: V1 2022-08-19

NANLITE

 +86-754-85751187

 +86-754-85300887

 service@nanlite.com

 Zhanglin,324,Dongli Chenghai Shantou Guangdong China

www.nanlite.com