

## **AIRCROSS 3**

User Manual

用户手册

## MOZA AirCross 3 Overview

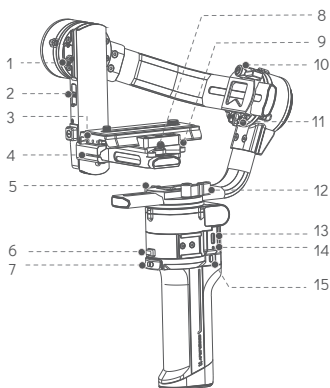

1. Tilt Motor Lock
2. Extension Port
3. Quick Release Plate
4. Tilt Adjustment Slider
5. Pan Motor Lock
6. Foldable Safety Lock
7. Smart Trigger
8. Quick Release Plate Knob
9. Quick Release Baseplate Knob
10. Roll Knob
11. Roll Motor Lock
12. Pan Knob
13. USB-C Charging Port
14. Battery Indicator Light
15. Power Button

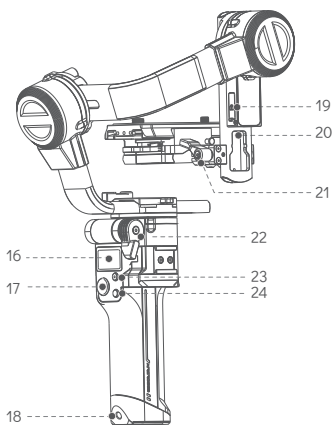

16. OLED Screen
17. Joystick
18. 1/4'' Extension Port
19. Camera Control Port
20. AI Extension Port
21. Tilt Knob
22. Foldable Knob
23. Camera Control Button
24. Function Button

## Preparation

### Unfold the Gimbal

1. Rotate the foldable Knob;
2. Unfold the handle until it is locked.
3. Tighten the knob to prevent the handle from loosening.

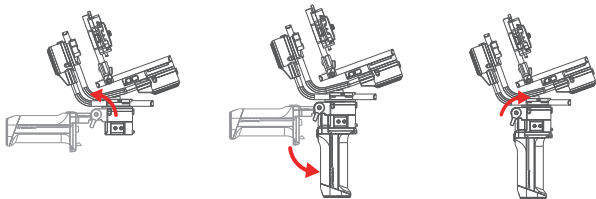

### Attaching the Tripod

1. Screw the mini tripod into the screw hole at the bottom of the handle.
2. Expand the mini tripod

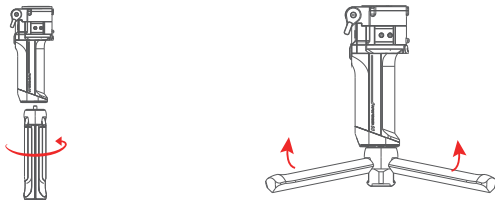

### Battery Charging

Please charge the battery through the USB-C charging port using a USB-C cable (Included) and a USB adapter (Not included). It is recommended to use a USB adapter with QC2.0 or PD protocol to complete the charging quickly. The LED light below the charging port will switch off after the charging is completed.

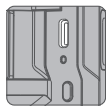

USB-C Port

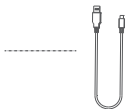

USB Type-C Cable

## Unlock the Gimbal

Rotate the motor lock to the unlocked position, and then each motor can rotate freely.

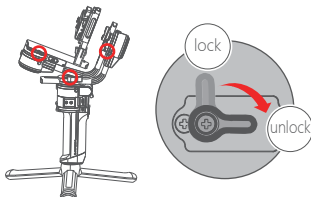

**⚠ Note:** Do not rotate the motor before unlocking, otherwise the motor lock may be damaged. If the gimbal is turned on before unlocking, the gimbal will enter sleep mode.

## Mounting the Camera

Make sure to prepare the camera before mounting, confirm the battery is fully charged and a memory card with sufficient storage space is inserted.

1. Place the camera on the quick release plate with 1/4" or 3/8" screws and keep the camera in the center. Remove the extra screws as a spare.

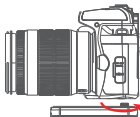

2. Slide the quick release plate onto the baseplate to the locked position.

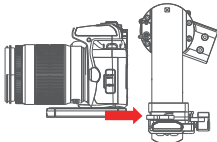

3. Secure the quick release plate and tighten the knob, make sure the quick release plate is locked.

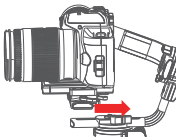

**⚠ Note:**

- a. When installing the camera, if the right side of the camera interferes with the tilt arm caused the installation to fail, loosen the knob of the quick-release baseplate and move it to the left until the camera can be installed successfully.
- b. After the camera is installed, move the quick-release baseplate to the right and make sure the camera's right side is aligned with the tilt arm to achieve the best stability.

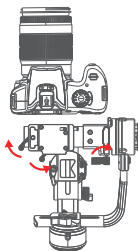

## Balance Adjustment

### 1. Balancing the tilt axis vertical

- a. Rotate the camera so that the lens is pointing upward
- b. Unlock the tilt axis and loosen the knob, slightly adjust the position of the tilt adjustment slider.
- c. The balancing is completed when the camera is steady while pointing upward, lock the tilt axis.

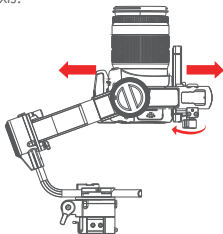

### 2. Balancing the tilt axis horizontal

- a. Rotate the camera so that the lens is pointing forward;
- b. Unlock the quick release plate, slightly adjust the position of the plate;
- c. The balancing is completed when the camera is steady while pointing forward, lock the quick release plate.

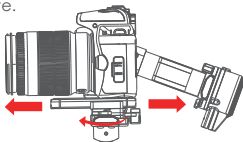

### 3. Balancing the Roll Axis

- Unlock the Roll axis.
- Slightly adjust the roll arm left and right until it's completely horizontal.
- Lock the roll axis.

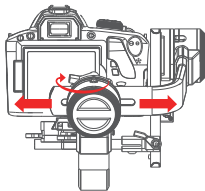

### 4. Balancing the Pan Axis

- Hold the gimbal at an angle of 45° horizontally, turn the pan arm to a horizontal angle.
- Unlock the Pan axis and slightly adjust the pan arm left and right.
- The Pan axis is balanced when the camera is steady, lock the pan axis.

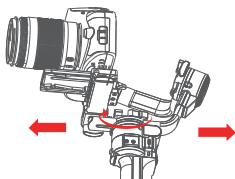

## Operation



#### Power Button

Long Press: Power on or off

One Click: Switch the follow speed, 5 levels from slow to fast

Double-click: Enter or exit sleep mode.

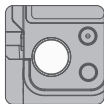

#### Joystick

Control the rotation of the gimbal

Menu:

Top Button: Option-up

Down Button: Option-down

Left Button: Return

Right Button: Confirm

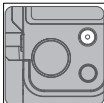

#### **Camera Control Button**

Press halfway: Autofocus

One click: Start recording

Press and hold for 3 seconds: take a photo

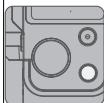

#### **Function Button:**

One Click: Follow mode (Pan-Tilt Follow, All Lock)

Double Click: Sport Gear Mode

Triple Click: Inception Mode

Long Press: Enter/Exit Menu



#### **Trigger Button**

One Click: Start/Stop AI Follow Mode

Double Click: Re-center

Triple Click: Selfie Mode

Press and Hold: All Lock

One Click and Hold: Pan-tilt Follow

## **Advanced Features**

Please visit [www.gudsen.com](http://www.gudsen.com) for the complete user manual. It will guide you:

- Language Switch
- Camera Control
- Button Customization
- Motor Output
- FPV, Sport Gear Mode, Manual Positioning
- User Configuration
- Calibration and Firmware Updates

## **MOZA Master App**

Scan the code or search in the app store to download the MOZA Master App. MOZA Master provides functions like Virtual Joystick Control, Motion Sensing Control, Parameter settings, Time-Lapse, Panorama, Calibration and Firmware Updates.

## Specifications

Model: AirCross 3

Weight: 1.3kg without tripod

Dimension: Unfold: 170\*190\*310mm,  
(W\*D\*H) folded: 52\*225\*270mm

Battery Type: Li-ion Intelligent Battery(built-in), 24.718Wh

Battery Capacity: 3400mAh

Standard Voltage: 7.27V

Charging Voltage: 5V/2A, 9V/2A

Working hours: 20H

Fast-charging time: 1.4H

Bluetooth: BT5.0, 2.400 GHz -2.4835 GHz

Environmental Working temperature: -10 C -50 C;  
requirements: Charging temperature: 5 C-40 C

## Safety Caution

1. This product is powered by a built-in battery; please do not disassemble it, do not put it into liquid or fire in order to avoid damage or risk of injury.
2. Before powering on the gimbal, please adjust the balance follow the instructions in this document. If the gimbal works in an unbalanced state for a long time, the surface temperature of the motor can get hot, which will seriously shorten the battery life.
3. Do not let children touch and use this product, do not use fingers to obstruct the motor operation to avoid finger injury.
4. This product is not waterproof or dustproof; please keep the gimbal clear of dust and water to avoid damage.



## 认识AirCross 3

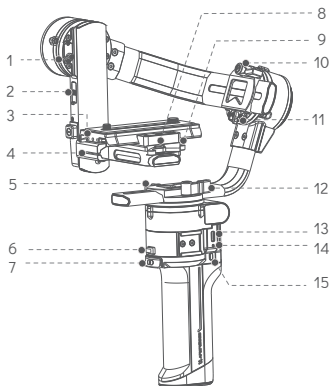

1. 俯仰电机锁
2. 外设扩展接口
3. 快装板
4. 俯仰调节滑块
5. 航向电机锁
6. 折叠安全锁扣
7. 扳机键
8. 快装板锁紧扳手
9. 快装板底座缩紧扳手
10. 横滚臂锁紧旋钮
11. 横滚电机锁
12. 航向臂锁紧旋钮
13. USB-C充电接口
14. 充电指示灯
15. 电源键

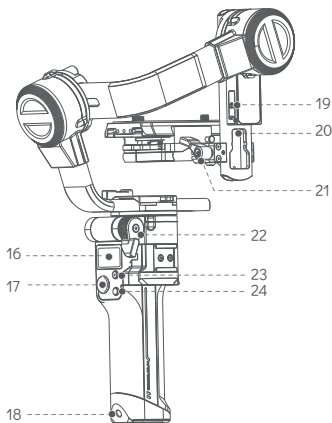

16. OLED显示屏
17. 摇杆
18. 1/4" 螺丝孔
19. 相机控制接口
20. AI拓展接口
21. 俯仰臂锁紧旋钮
22. 折叠锁紧旋钮
23. 录制键
24. 功能键

## 准备

### 展开云台

1. 折叠锁紧旋钮；
2. 将手柄折回到竖直位置，直到折叠安全锁扣已经锁住手柄；
3. 锁紧折叠锁紧旋钮，防止手柄松动。

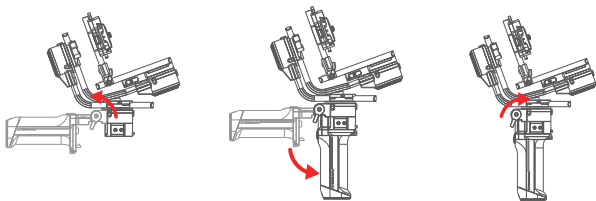

### 安装三脚架

1. 将三脚架拧入手柄底部的螺丝孔中
2. 展开三脚架的支撑脚。

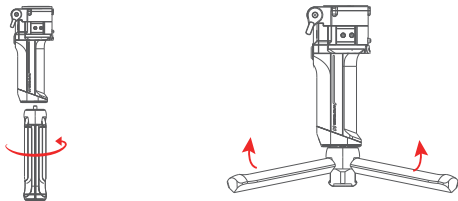

### 充电

请自备USB充电器，通过包装内含的USB-C线缆，连接到OLED屏幕左侧的USB-C接口上，给云台充电。推荐使用满足QC2.0或PD协议的USB充电器，能够快速完成充电，充电完成后，充电接口下方的LED灯会熄灭。

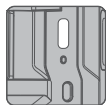

USB-C接口



USB充电线

## 解锁

将电机锁旋转至解锁位置，各个电机即可自由转动。

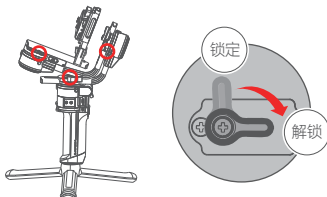

**⚠ 注意：**切勿在未解锁前暴力转动电机，否则可能造成电机锁损坏。如果未解锁前进行开机，云台会进入休眠状态。

## 安装相机

安装相机前，请确保相机已经装入电量充足的电池和存储空间足够的存储卡，确保相机已经准备好拍摄工作。

1. 将相机通过1/4" 或者3/8" 螺丝固定到快装板上，相机重量分布尽量均匀，多余的螺丝可取下备用；

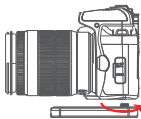

2. 将快装板滑入快装底座中，直到安全销卡住快装板；

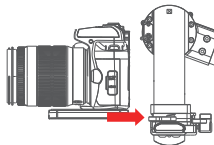

3. 锁紧快装板锁紧扳手，确认快装板无法滑动；没有锁紧时，可往复扳手多次锁紧。

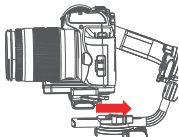

**注意：**

- 若装入相机时，相机右侧与俯仰臂干涉无法安装，可松开快装底座锁紧扳手，将快装底座向左侧移动，直到相机能顺利安装；
- 安装好相机后，请将快装底座尽量向右移动，使相机右侧靠齐俯仰臂，以达到最佳的系统稳定性。

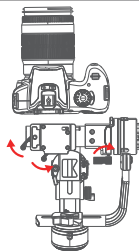

## 调节平衡

### 1. 上下：

- 将相机转动到镜头朝上；
- 松开俯仰臂锁紧旋钮，轻微调节俯仰锁紧滑块的位置；
- 当镜头能保持向上，不再转动后，调节完毕，锁紧俯仰臂锁紧旋钮。

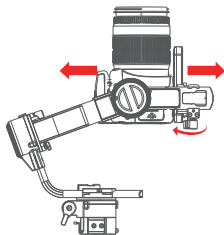

### 2. 左右：

- 将相机转动到镜头朝前；
- 松开快装板锁紧扳手，轻微调节快装板的位置；
- 当镜头能保持向前，不再转动后，调节完毕，锁紧快装板锁紧扳手。

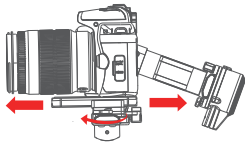

### 3. 横滚:

- 松开横滚臂锁紧旋钮;
- 左右微调横滚臂, 直到横滚臂完全水平, 不偏向一侧;
- 锁紧横滚臂锁紧旋钮。

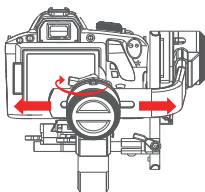

### 4 航向:

- 倾斜45°握持云台, 将航向臂转动到水平角度;
- 松开航向臂锁紧旋钮, 左右微调航向臂;
- 当航向臂能保持水平, 调节完成, 锁紧航向臂锁紧旋钮。

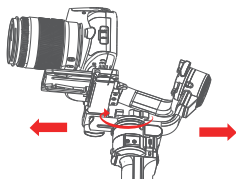

## 开机使用



#### 电源键:

长按: 开机、关机

单击: 切换跟随速度, 从慢到快5个级别

双击: 休眠、唤醒

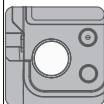

#### 摇杆:

主界面: 控制云台转动

菜单界面:

上: 选择条上移

下: 选择条下移

左: 返回

右: 确认

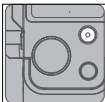

#### 拍摄键：

半按：对焦

全按：录制

全按3秒：拍照



#### 功能键：

单击：切换跟随模式

(航向跟随、航向-俯仰跟随、全跟随、全锁定)

双击：急速跟随，能提供最大的转向跟随速度

三击：盗梦空间，可拍摄360°旋转的画面

长按：进入、退出菜单



#### 扳机键：

单击：开始、停止AI跟随（需连接AI跟踪模块）

双击：归中

三击：自拍

按住：全锁定

单击按住：航向俯仰跟随

## 进阶使用

请访问官网 ([www.gudsen.com](http://www.gudsen.com)) 以获取更为详尽的电子档说明书，电子档说明书将会引导您进行以下内容的学习：

- 设置系统显示语言
- 如何连接并控制相机
- 自定义按键功能
- 设置电机出力
- 跟随、体感、手动定位等高级功能的应用与参数设置
- 菜单内的功能详解
- 云台校准与固件升级

## MOZA Master

扫码下载或在应用商店搜索‘MOZA Master’即可安装本App。MOZA Master能够提供虚拟摇杆控制、体感控制、云台参数设置、延时摄影、巨幅摄影等多种功能，也能校准云台以及升级云台固件。

## 规格参数

型号: AirCross 3

重量: 1.3Kg (不含三脚架)

尺寸: 完全展开约为170\*190\*310 mm  
折叠后约为52\*225\*270mm

电池类型: 内置智能电池, 24.718Wh

电池容量: 3400mAh

标称电压: 7.27V

充电电压: 5V/2A、9V/2A

最长续航时间: 20H

最快充电时间: 1.4H

蓝牙: BT5.0, 2.400 GHz -2.4835 GHz

环境要求: 工作温度: -10°C--50°C  
充电温度: 5°C--40°C

## 安全注意

1. 本产品内置电池, 请勿私自拆卸, 请勿投入液体或者火中, 以免造成危险;
2. 开机使用前请按照本文档的说明, 调节好平衡, 云台长时间工作在不平衡状态下将导致电机表面温度较高, 并且将会严重缩短续航时间;
3. 请勿让儿童接触和使用本产品, 请勿用手指阻碍电机运行, 以免夹伤手指;
4. 本产品不防水, 不防尘, 使用时请注意防水、防尘, 以免造成损坏。

# 产品保修卡

## 用户资料

产品型号	MOZA AirCross 3
购买日期	
姓 名	
电 话	
地 址	

经销商信息（签章）

## 产品保修条例

### 保修期

自购机日起，云台主体保修12个月；云台电机、电池保修3个月。设备外壳、说明书、USB线材、包装等不在“一年免费保修服务”范围内，您可以选择有偿服务。

### 七日内免费退货

自购机日起7日内，根据国家最新三包规定，您可以选择退货（按票面金额一次性退清货款）、换货（更换同型号同规格的产品）或修理。

### 八至十五日免费换货或修理

自购机日起第8日至第15日内，主机出现性能故障，并经特约维修中心检测，确认非人为损坏的本身质量问题，您可以选择换货(更换同型号、同规格产品)或修理；但是更换的范围，只限于产品主机，其他配件无质量问题，不能更换；购买者在以下条件下不享受免费保修服务，您可以选择有偿服务。

1. 超过三包有效期的；
2. 无三包凭证及有效发货票的，但能够证明该产品在三包有效期内的除外；
3. 包修凭证上的型号与修理产品型号不符或者涂改的；
4. 非本公司特约维修人员拆卸造成损坏的；
5. 因不可抗拒力造成损坏的；
6. 未按产品使用说明书要求使用、维护、保养而造成损坏的。





Follow us  
魔爪社交媒体



MOZA WeChat  
魔爪微信公众号

**GUDSEN**

INVENTED FOR VIDEO

Shenzhen Gudsen Technology Co., Ltd

Web: [www.gudsen.com](http://www.gudsen.com)