

Electro Storm CS15

Product Manual

English

Table of Contents

Introduction	04
Components List	05
Product Overview	06
1. Lamp	06
2. Control Box	07
Setup.....	08
1. Installation and Removal of the CS15 Yoke.....	08
2. Disassembly and Installation of Aputure Mount Protection Cover.....	09
3. Installation and Disassembly of Standard Reflector/Adapter	10
4. Installation and Removal of the Barn Doors	11
5. Lamp Adjustment.....	13
6. Installation and Disassembly of the Control Box Dolly.....	13
7.Connection of Lamp with the Control Box.....	15
8. Power Supply Connections	16
Operating Instructions	17
1. Powering On/Off.....	17
1.1 Status Indicator Icons	17
2. Manual Control of Control Box	17
2.1 Light Mode	18
2.1.1 CCT.....	18
2.1.2 Adv.HSI	18
2.1.3 RGB	19
2.1.4 GEL.....	19
2.1.5 XY	19
2.1.6 Source.....	20
2.1.7 FX	20
2.2 Settings.....	21
2.2.1 Output Settings.....	21
2.2.2 High-Speed Mode	22
2.2.3 Dimming Curve.....	23
2.2.4 Control System	23

2.2.4.1 DMX	24
2.2.4.2 Sidus BT	26
2.2.4.3 CRMX	27
2.2.4.4 Ethernet.....	29
2.2.5 Studio Mode.....	32
2.2.6 Fan Mode.....	32
2.2.7 Firmware Update	33
2.2.8 Product Info.....	34
2.2.9 Custom FX	36
2.2.10 Language	36
2.2.11 Factory Reset	37
2.2.12 Accessory Control	38
2.2.13 Lead/Follow Mode.....	41
2.3 Presets	42
3. Control with DMX Console.....	43
3.1 Connect the Lighting Console to the Control Box DMX IN Port	43
4. DMX Control Operation.....	44
5. Downloading the Sidus Link APP.....	44
Product Specifications.....	45
Photometric Data	47
Safety Instructions	51
FCC Declaration of Conformity.....	53
RF Statement	53
Disclaimer	54

Introduction

The Electro Storm CS15 is a high output full-color point-source LED. The new dual-blue chip set allows for stunning spectrum accuracy across the entire dimming range. The light features electronic mounts that enable remote control of zoom, pan and tilt when compatible accessories are paired, through a single header cable between the lamp head and the Control Box that feeds both power and data.

The CS15 can be remotely controlled via industry standard protocols such as DMX512-A, LumenRadio CRMX, RDM, Art-Net, and sACN, as well as Sidus BT from Aputure. It is certified to IP65 weather protection for versatility and peace of mind when working in wet or dusty environments.

Components List

Please check whether the following items are contained in the package before using the product.

Please contact your dealer if there are any missing items.

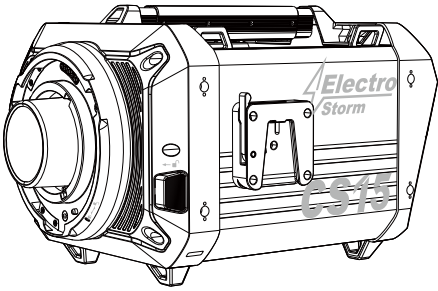

Electro Storm CS15 Lamp Head
x1

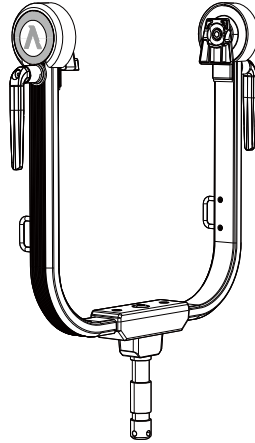

Removable CS15 Yoke
x1

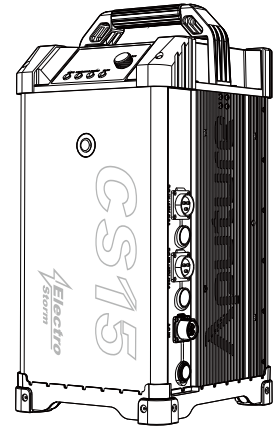

CS15 Control Box
x1

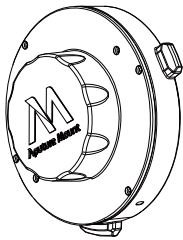

Aputure Mount
Protection Cover
x1

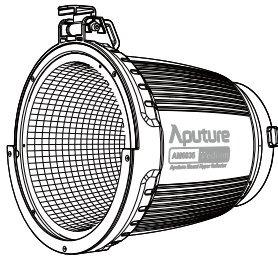

Aputure Mount
35° Reflector
x1

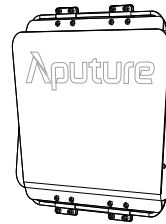

Barn Doors for Aputure Mount
Reflectors (35°/50°)
x1

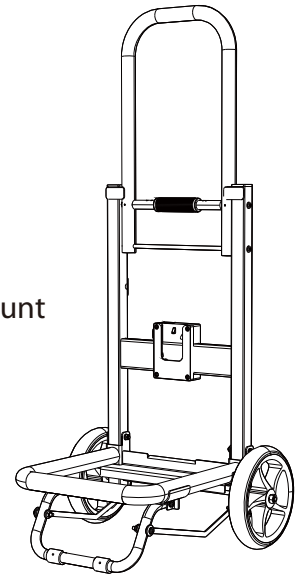

Control Box Dolly
x1



Waterproof Head Cable
(15m/590.55in)
x1

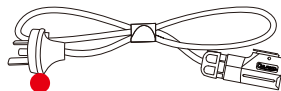

AC Power Cord
(6m/236.22in)
x1

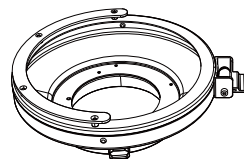

Aputure Mount
Barn Doors Adapter
x1

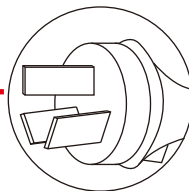
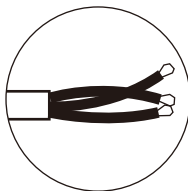

The illustration is for reference only since plug specifications can vary in different regions.

Statement: If you choose the AC power cord without a plug, we will not provide a plug and you need to purchase and assemble it separately.

* All illustrations in this manual are for reference only. The physical product may differ from the schematic diagram due to continuous updates and upgrades.

Product Overview

1. Lamp

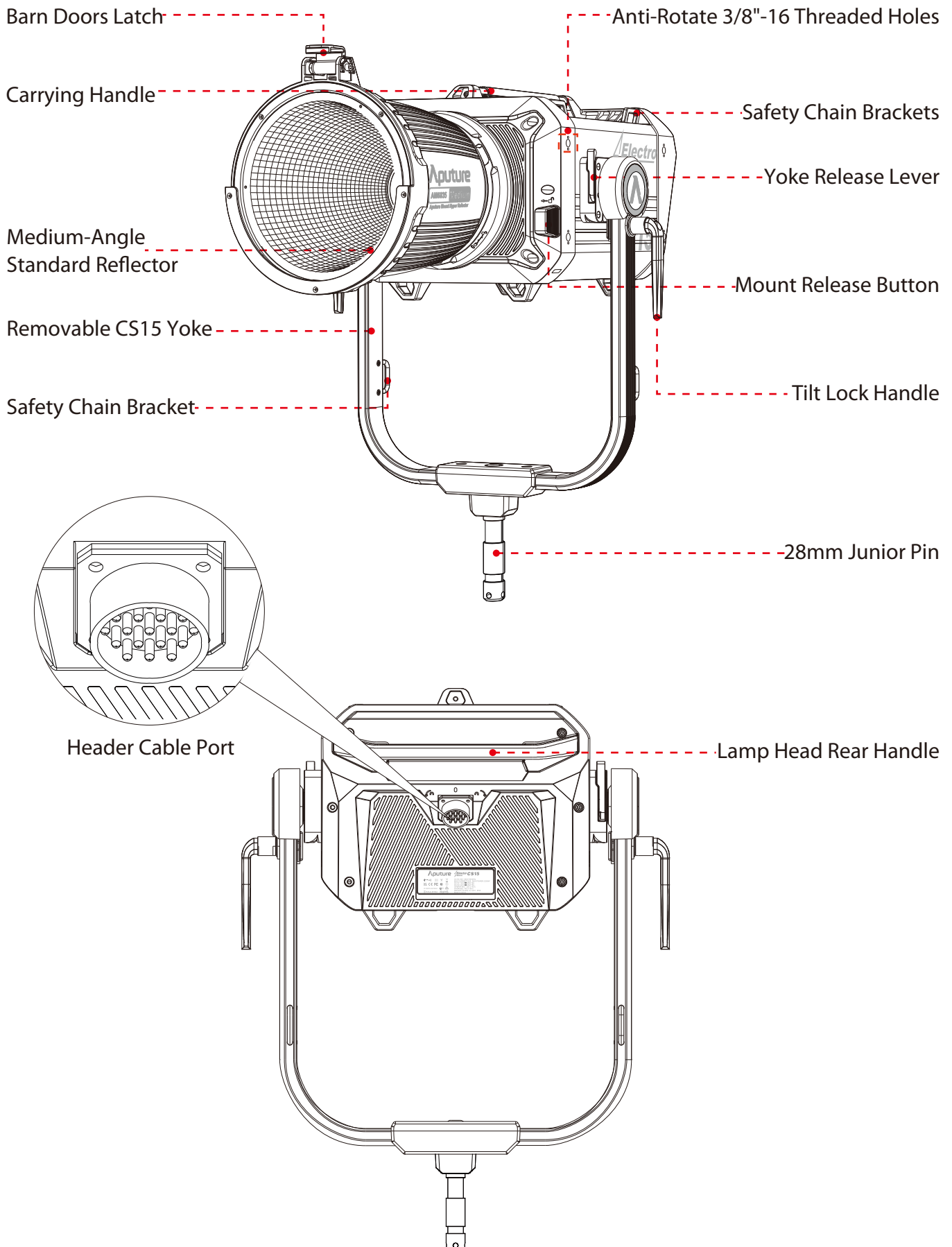

2. Control Box

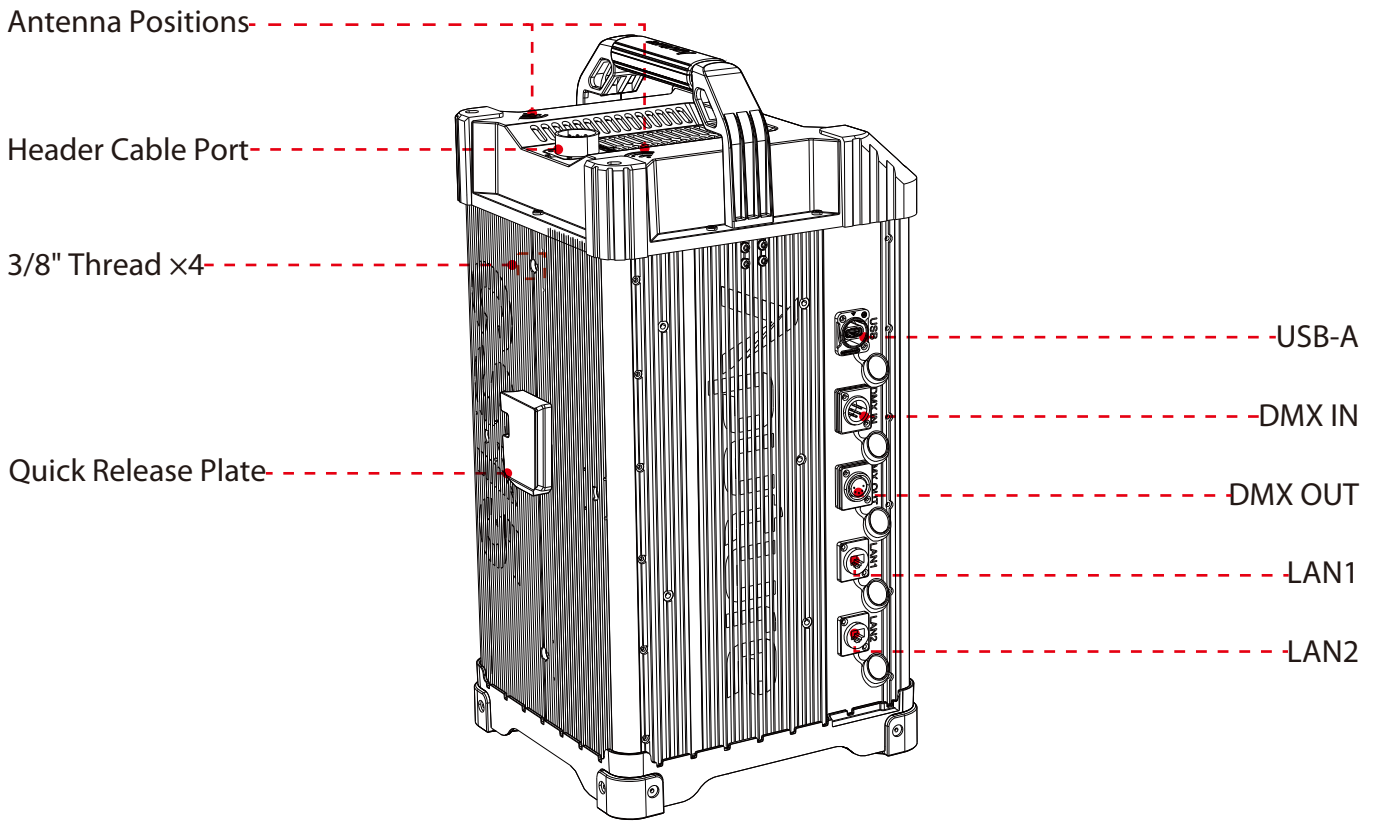
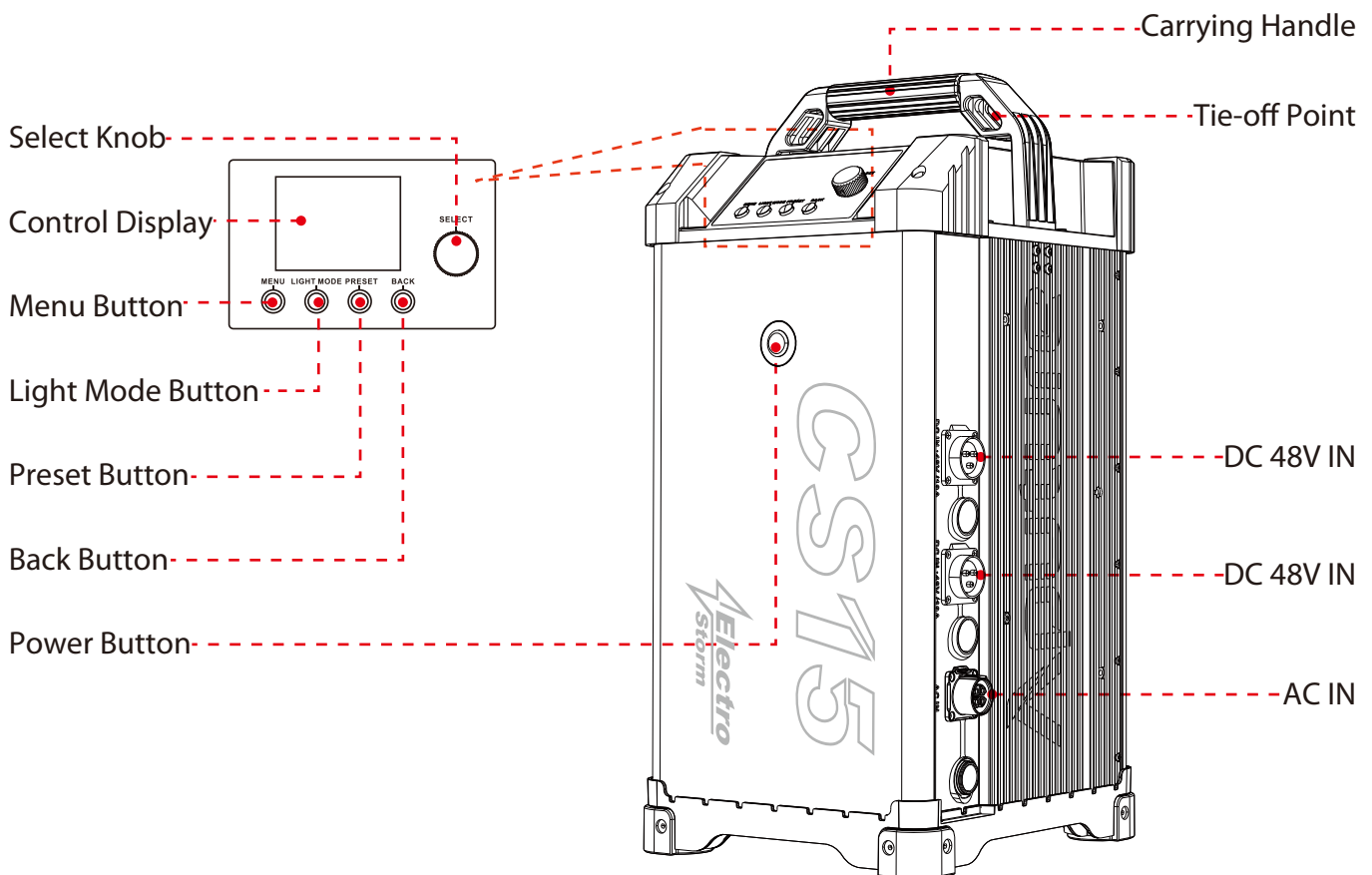

Setup

1. Installation and Removal of the CS15 Yoke

① Installation of CS15 Yoke

Insert the CS15 Yoke's Junior Pin into a rigid Junior Receiver and lock in place. Align the lamp head with the quick release plates on both sides and install until locked.

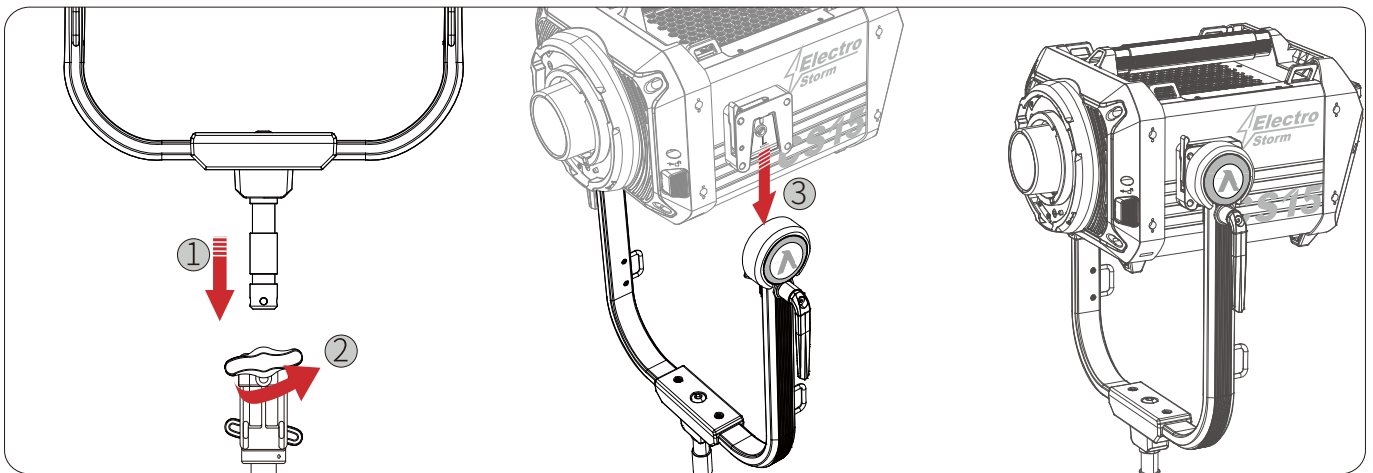

② Disassembly of CS15 Yoke

While holding the Carrying Handle of the lamp, turn the Yoke Release Lever on both sides of the yoke until they unlock. Lift the lamp head upwards to remove it from the yoke.

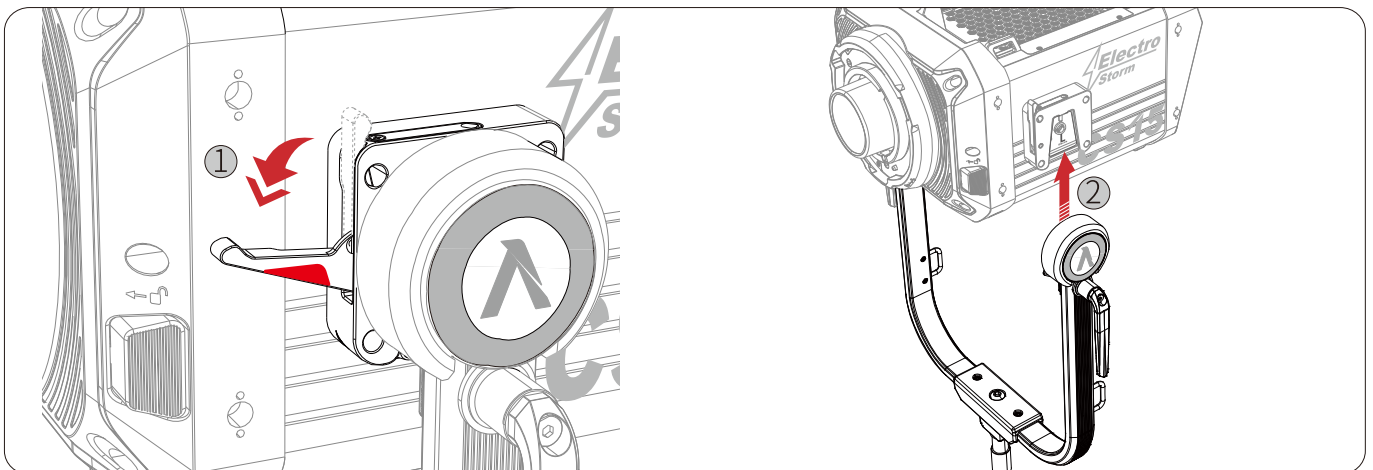

* The Yoke Release Levers will display red on the sides if the lamp is not completely seated and locked. Please re-align and insert the lamp again until the Yoke Release Levers show no red and a "click" noise of the plate locking has been heard.

* It is recommended to install and disassemble the lamp and yoke while the yoke is sturdy and upright.

2. Disassembly and Installation of Aputure Mount Protection Cover

Press the button in the direction indicated by the arrow and rotate the protection cover. Rotate the protection cover in the reverse direction for its installation.

Disassembly of protection cover

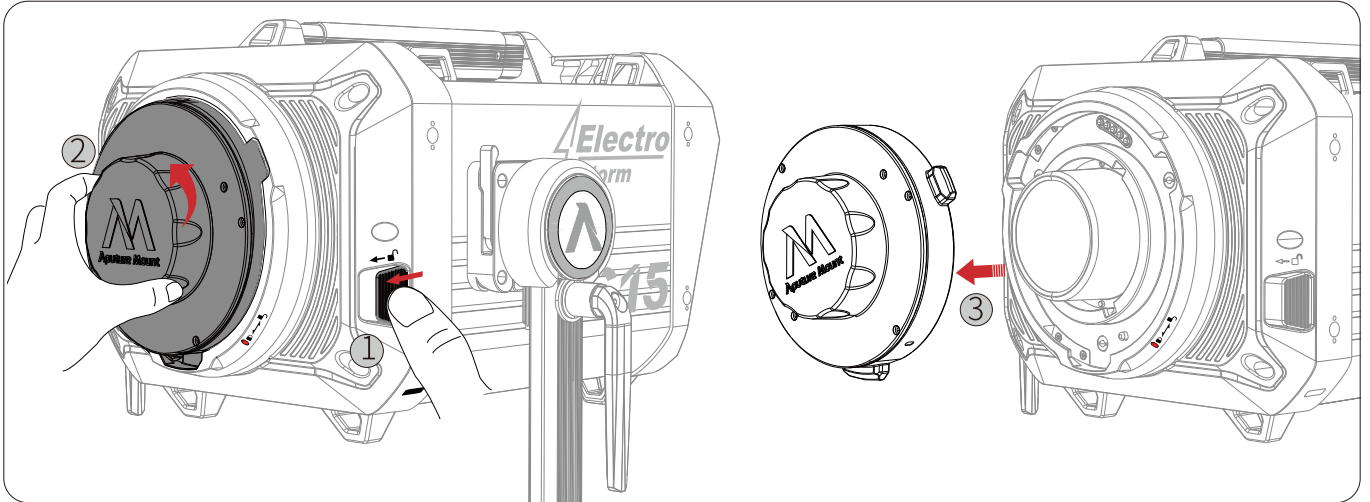

Installation of protection cover

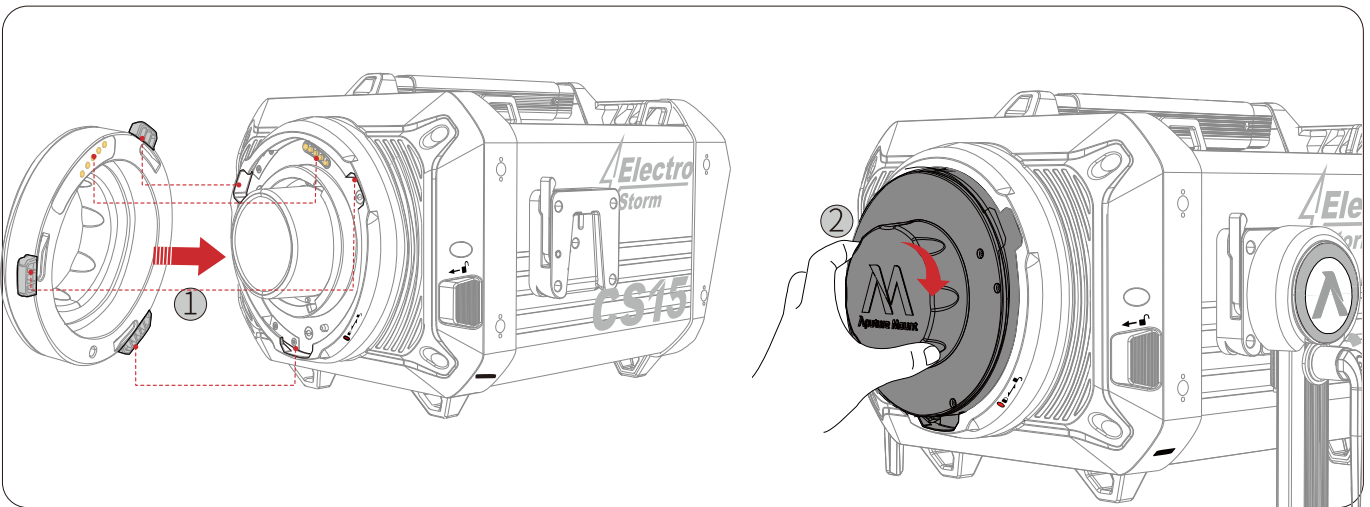

* Make sure to remove the Aputure Mount Protection Cover before using the device. Install the Aputure Mount Protection Cover for transport and storage.

3. Installation and Disassembly of Standard Reflector/Barn Doors Adapter

Press the Mount Release Button and insert and rotate the Standard Reflector/Adapter until it locks in place; reverse to remove.

Installation of Standard Reflector

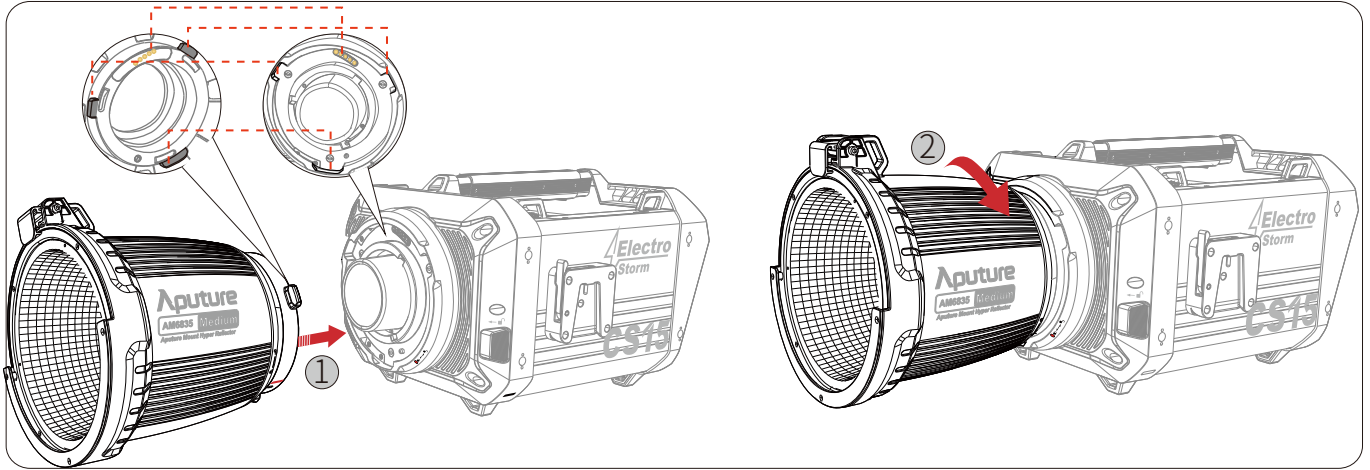

Removal of Standard Reflector

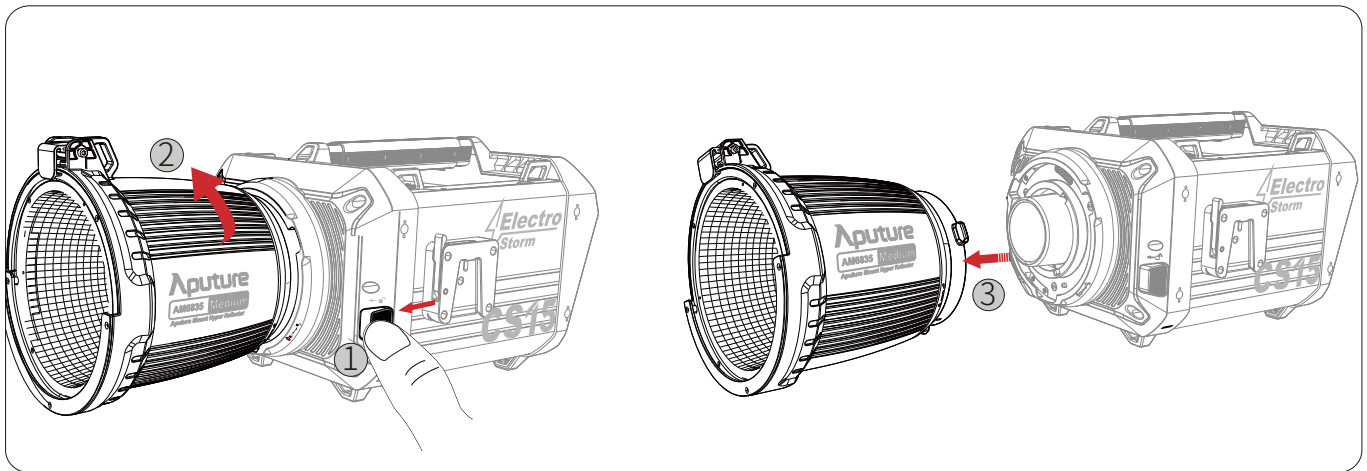

Installation of Barn Doors Adapter

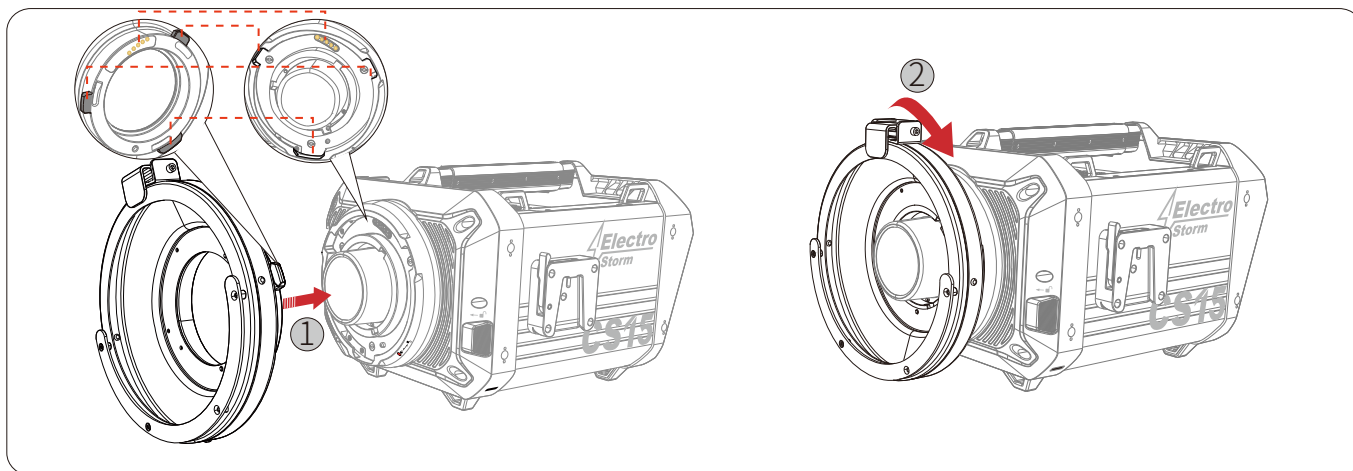

Removal of Barn Doors Adapter

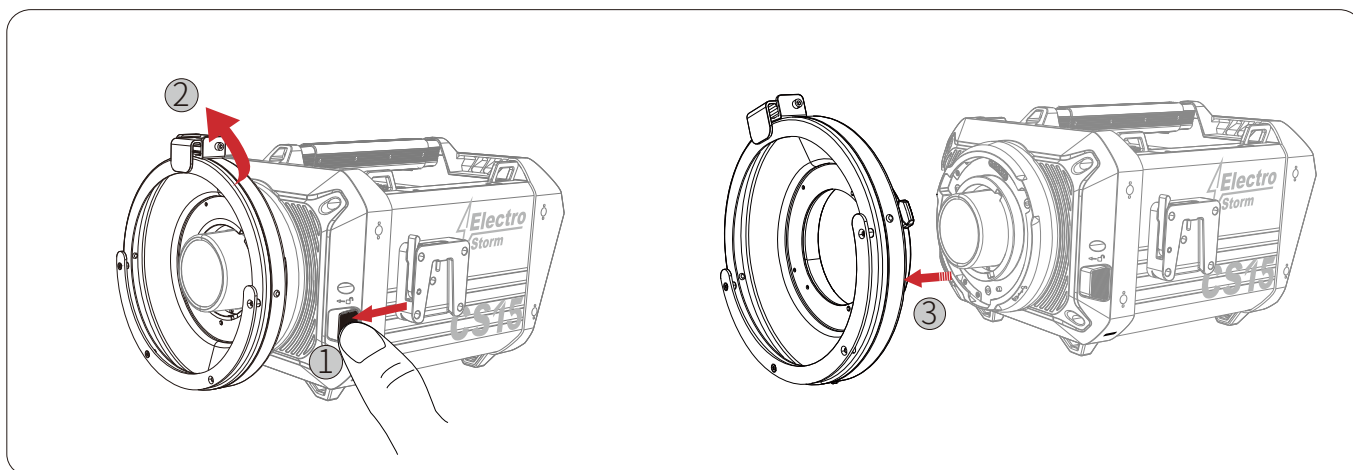

4. Installation and Removal of the Barn Doors

With Barn Doors Adapter

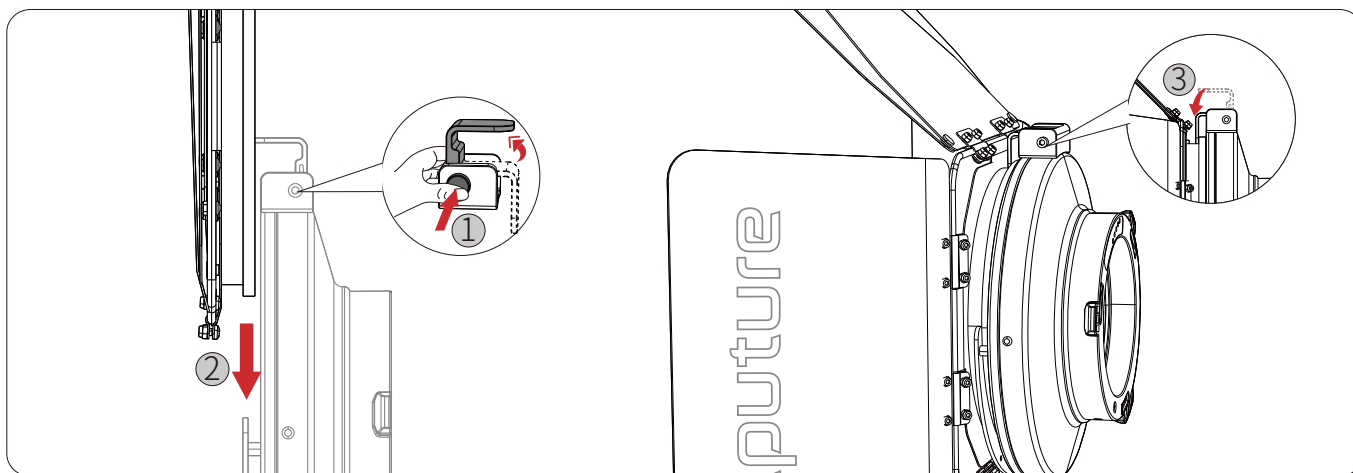

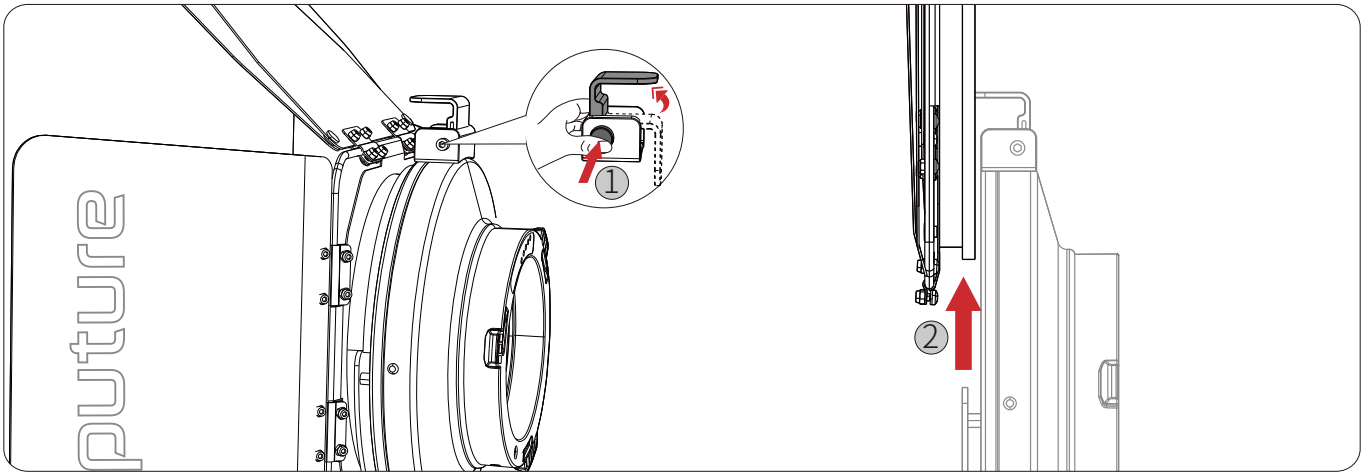

With Standard Reflector

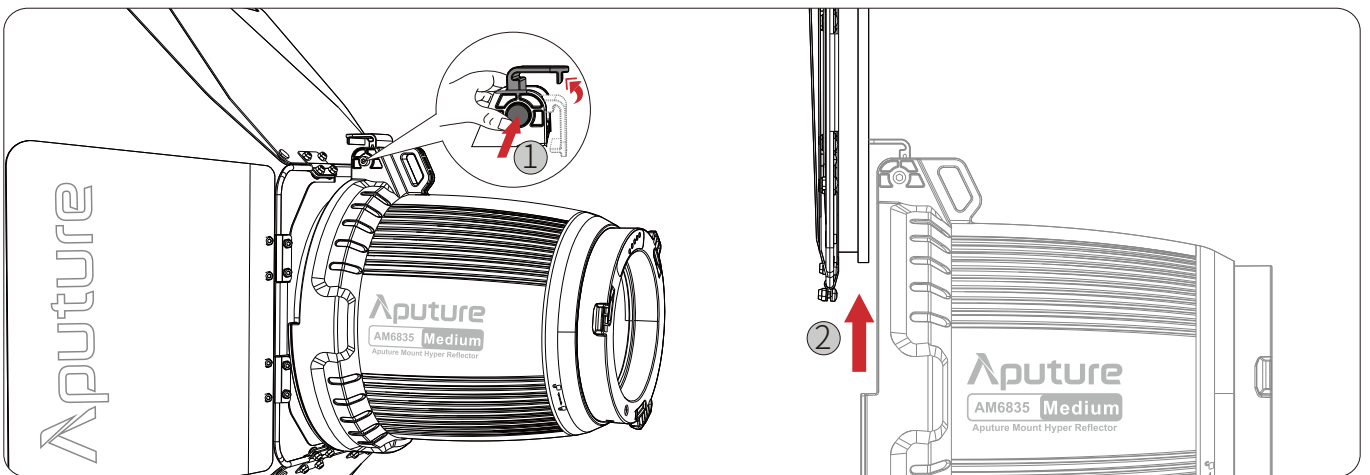
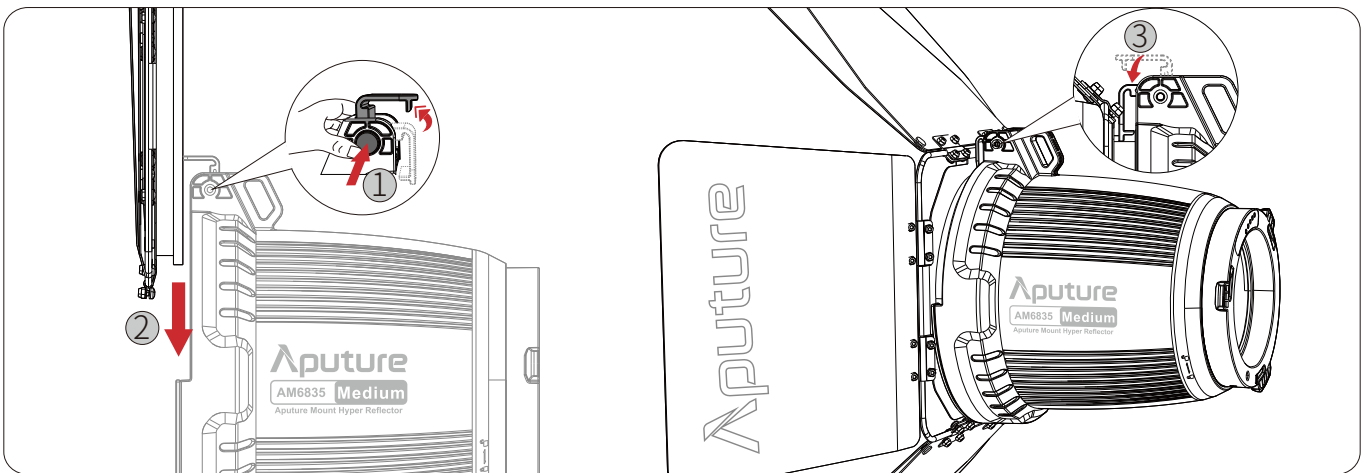

5. Lamp Adjustment

The lamp angle can be adjusted by loosening the disc brake handles.

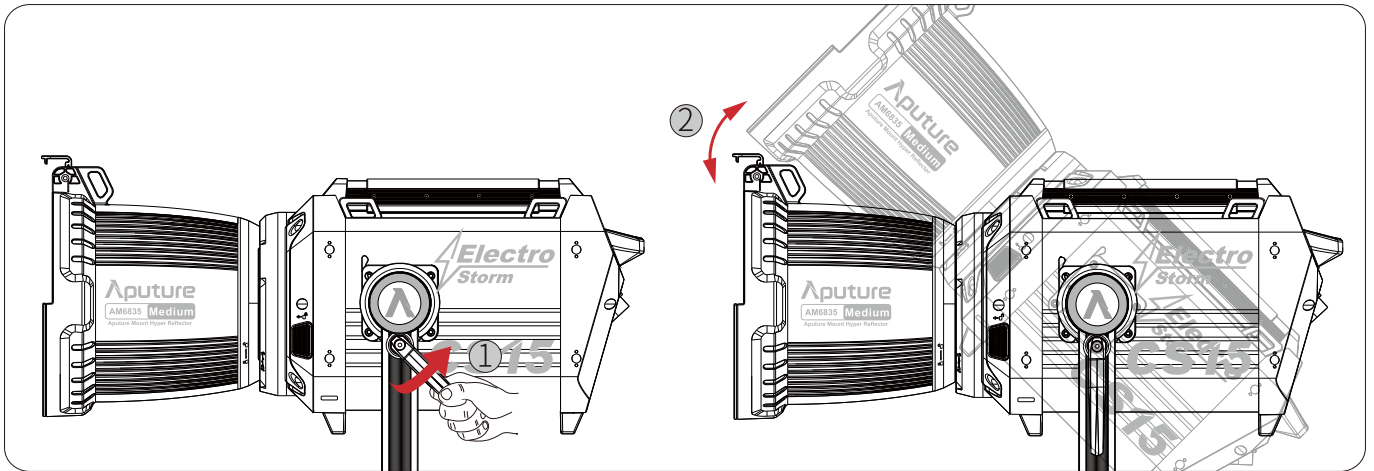

6. Installation and Disassembly of the Control Box Dolly

① Unfold the Control Box Dolly

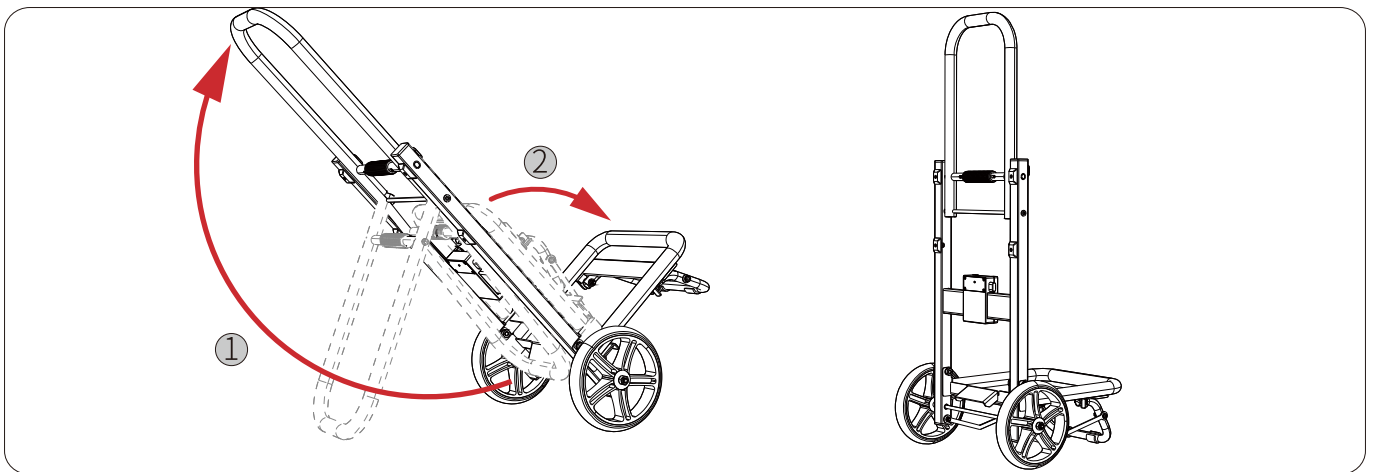

② Lift the Control Box and install it into the quick release mechanism of the dolly

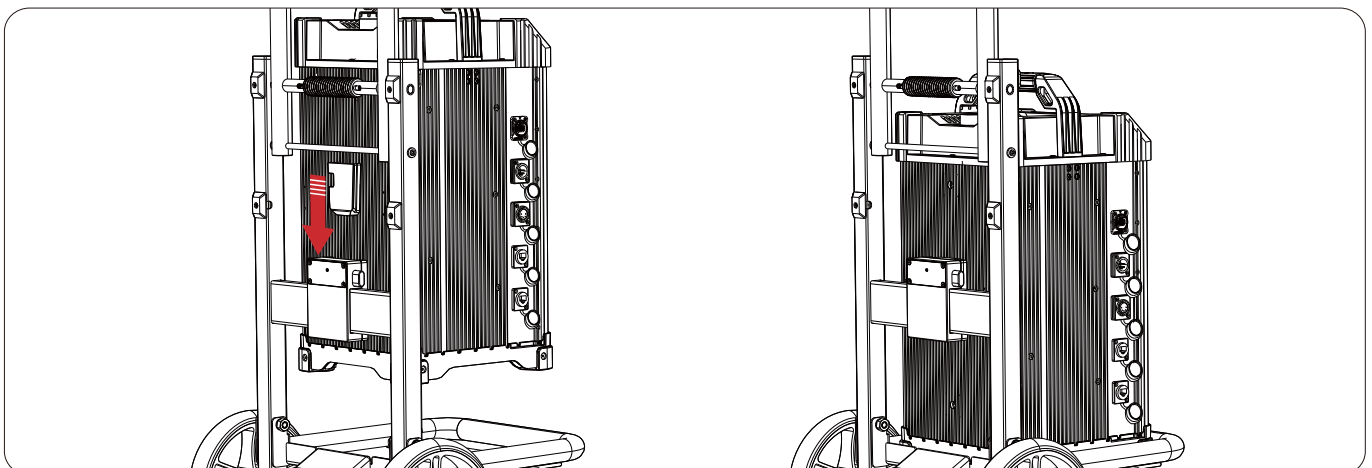

③ To remove the Control Box from the dolly, press the release button and lift up on the Control Box

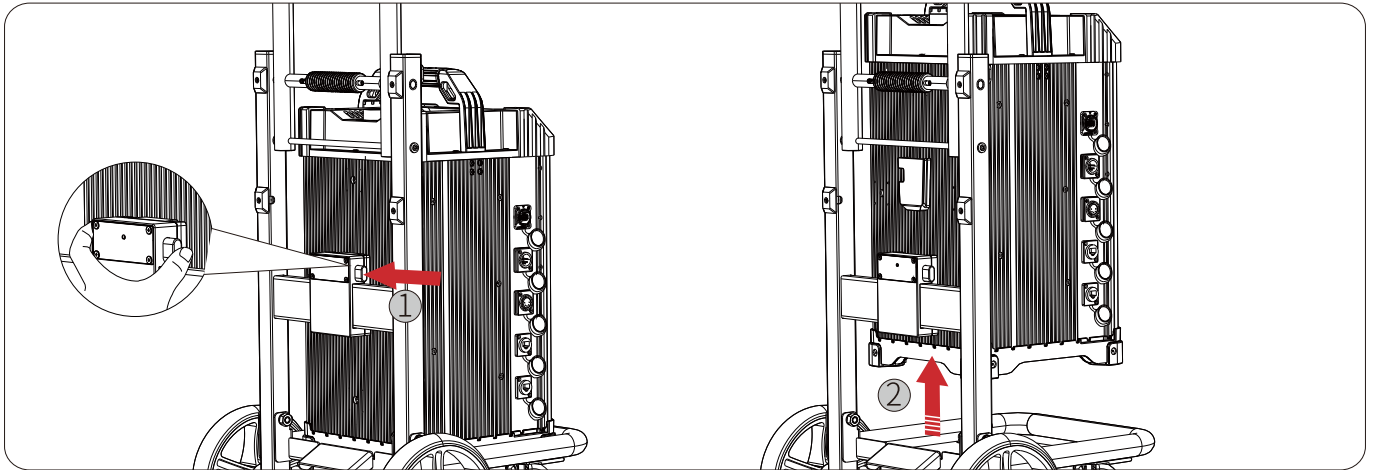

④ Fold and store the dolly

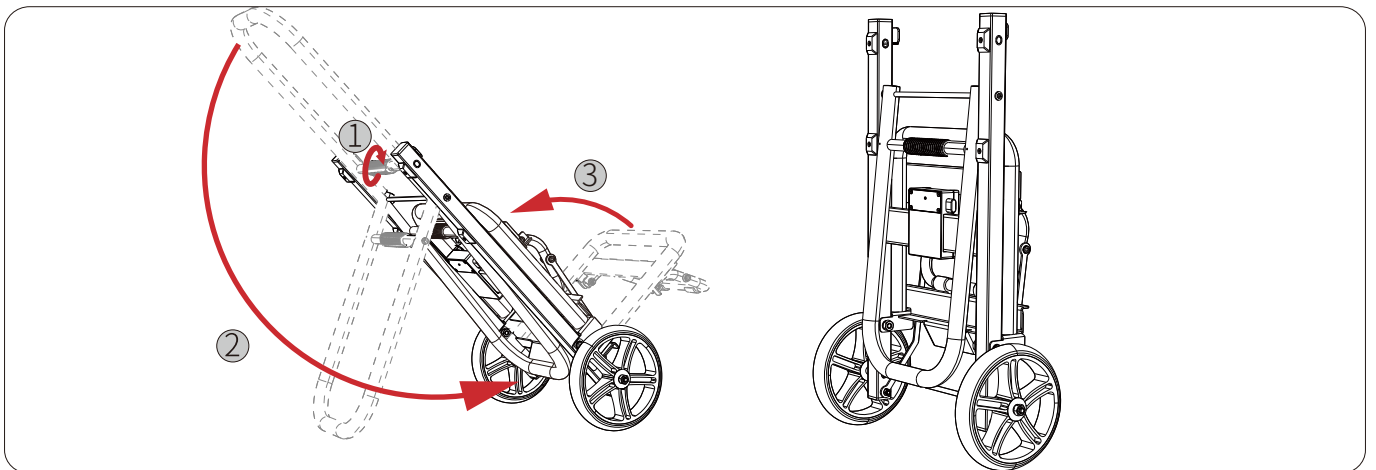

7. Connection of Lamp with the Control Box

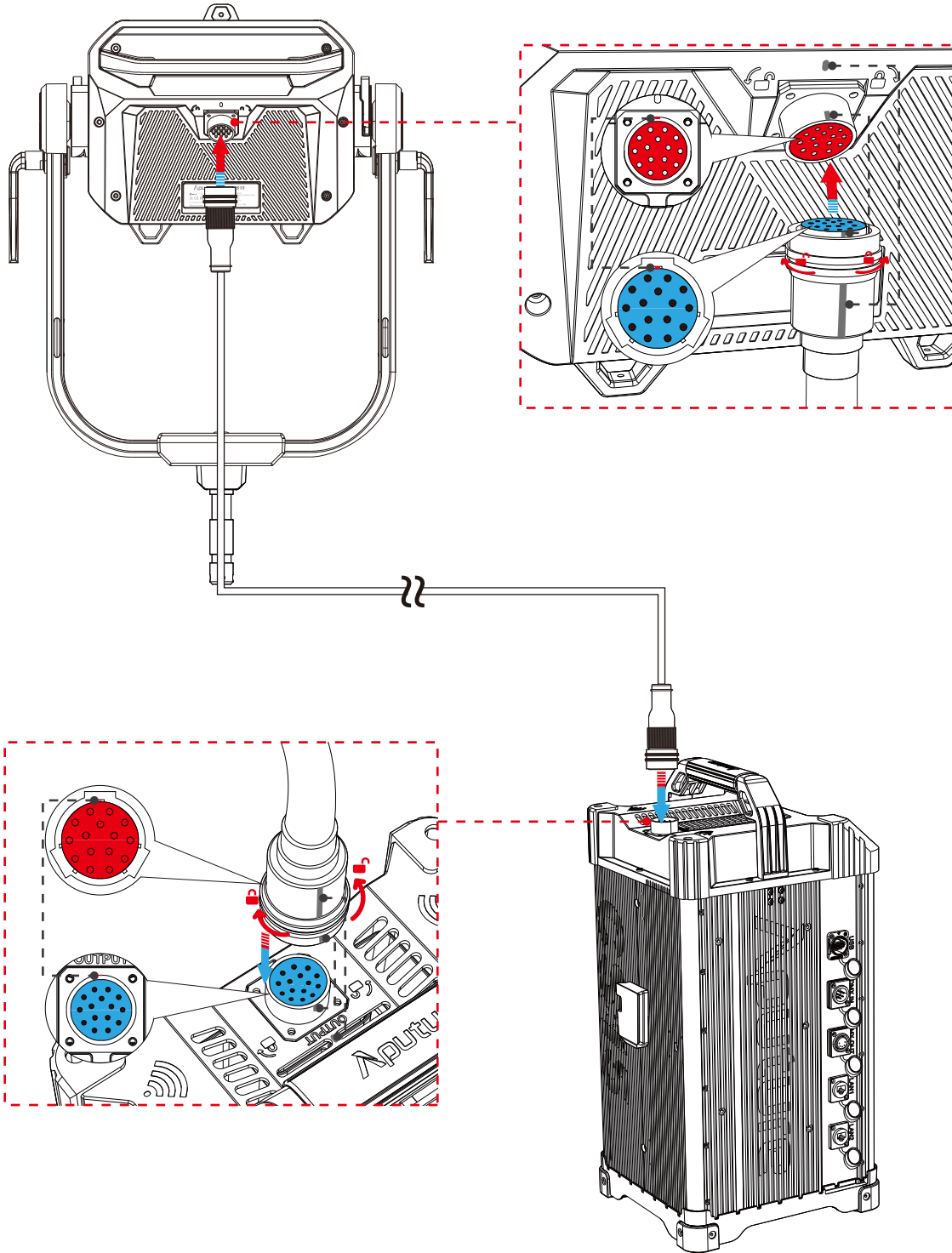

8. Power Supply Connections

① AC power supply

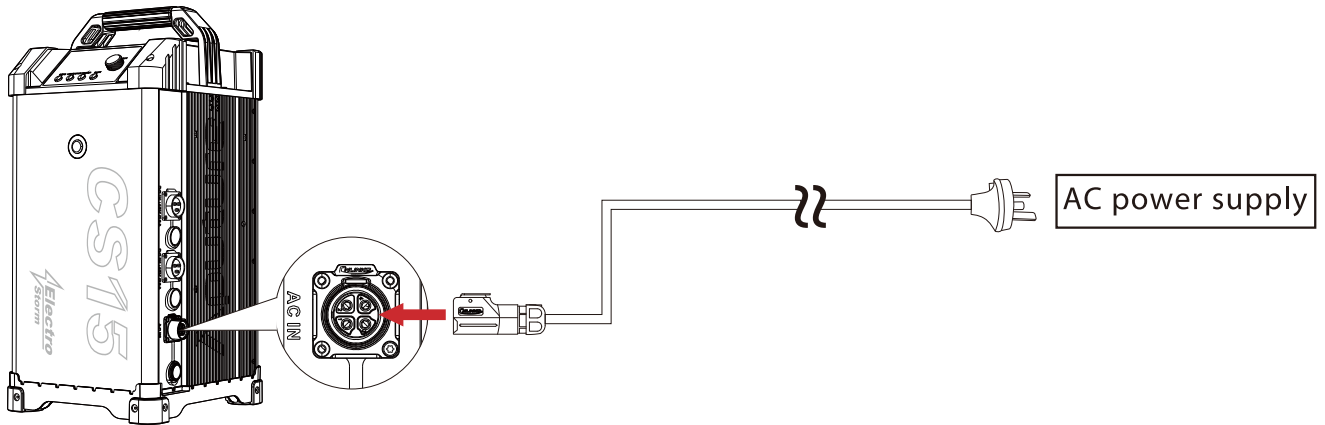

② DC power supply

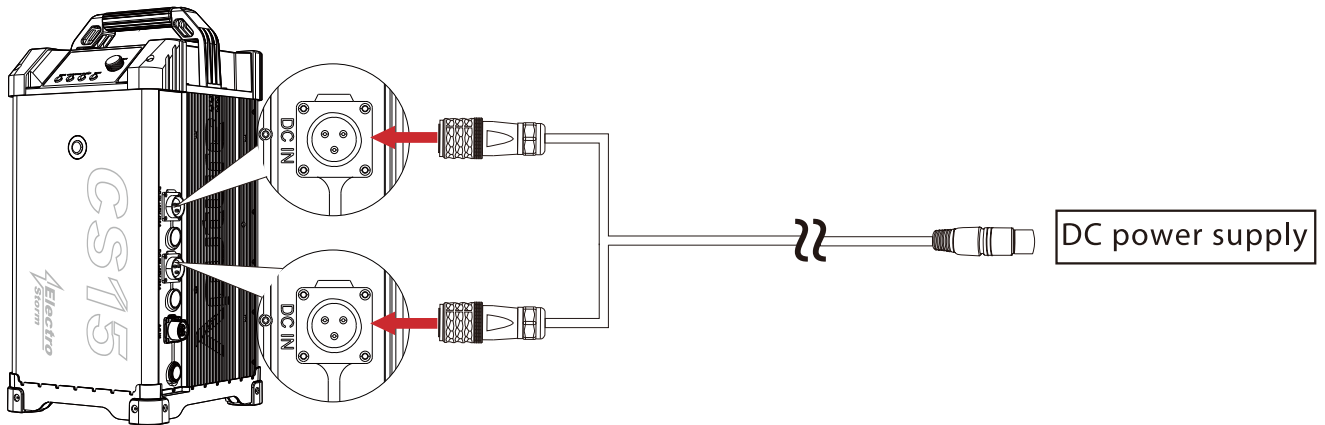

Note:

1. DC power cable needs to be purchased separately.
2. The connected DC power supply needs to support 1800W (48V/38A).

Operating Instructions

1. Powering On/Off

Connect the power supply and press the power button on the Control Box to turn on/off.

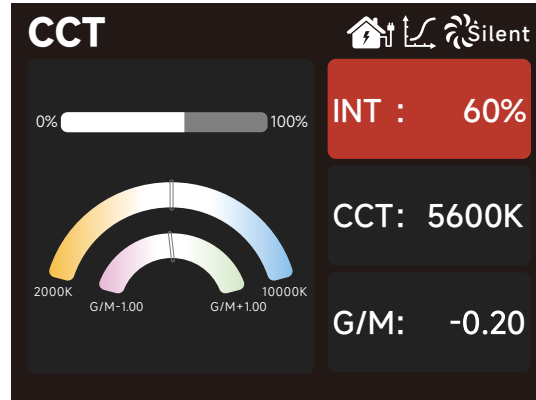
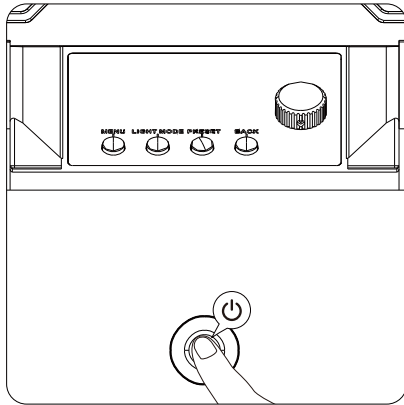

Note: If your fixture has Studio Mode "ON", the Control Box will power on whenever power is supplied to it.

1.1 Status Indicator Icons

Lead/Follow Mode: Leader		Sidus Bluetooth	
Lead/Follow Mode: Follower		Receiving CRMX data	
Fan Mode:		Receiving CRMX/DMX data not present	
		CRMX Linked/No TX present	
		Network Control Protocol present	
		AC Power Detected	
Dimming Curve: Linear		15 Amp Power Cable Detected	
Dimming Curve: S-Curve		DC power supply: DC interface 1	
Dimming Curve: Exp		DC power supply: DC interface 2	
Dimming Curve: Log			

2. Manual Control of Control Box

Press the button on the Control Box to enter the corresponding modes: MENU, LIGHT MODE, and PRESET.

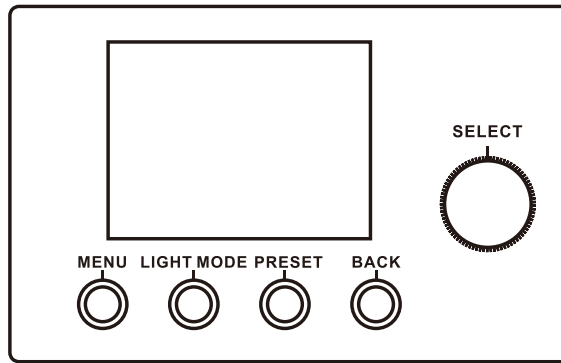

2.1 Light Mode

Press the “Light Mode” button to enter the menu interface, which consists of CCT, Adv.HSI, RGB, GEL, XY, SOURCE and FX.

2.1.1 CCT

Adjust the Color Temperature (2000K-10000K) and the Green/Magenta level (-1.00 thru +1.00).

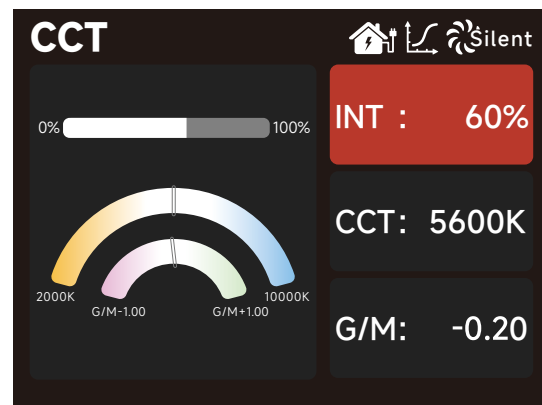
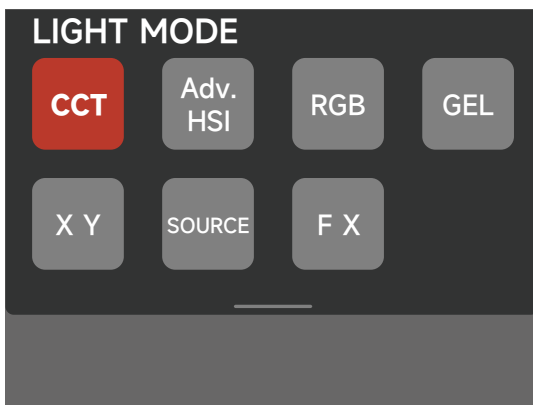

2.1.2 Adv.HSI

Select the Hue (0°-360°), Saturation (0-100%) and Color Temperature (2000K-10000K).

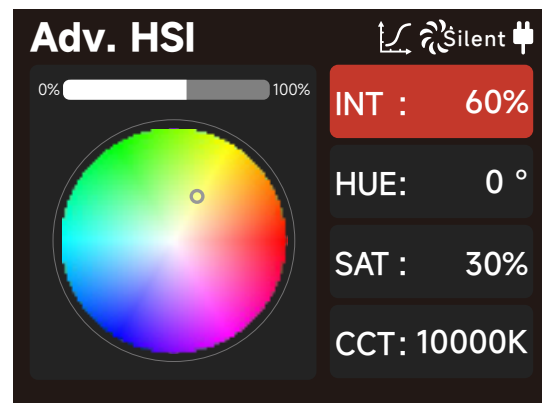
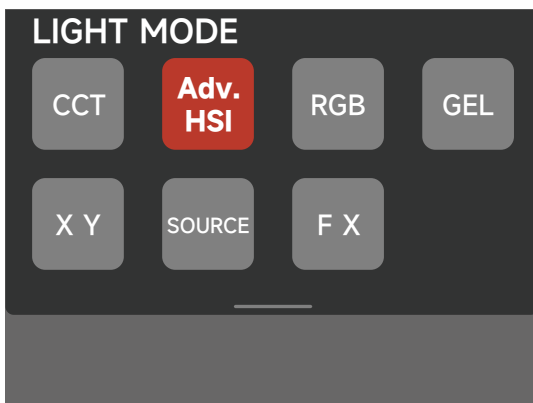

2.1.3 RGB

Set the values of Red, Green and Blue (0-100%) to achieve the desired color; then use the Master Intensity to raise and lower the overall brightness of the fixture without changing the colors individually.

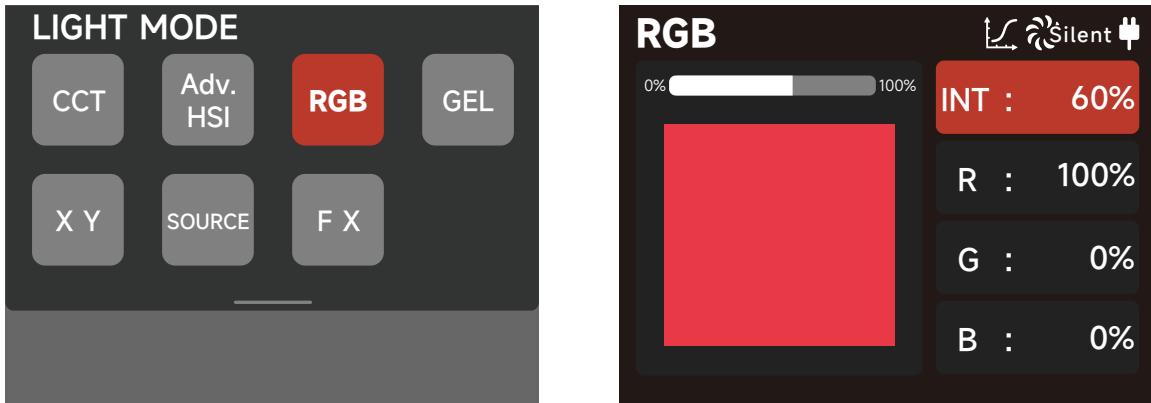

2.1.4 GEL

Select the Intensity, base Color Temperature, Gel Series and desired Gel.

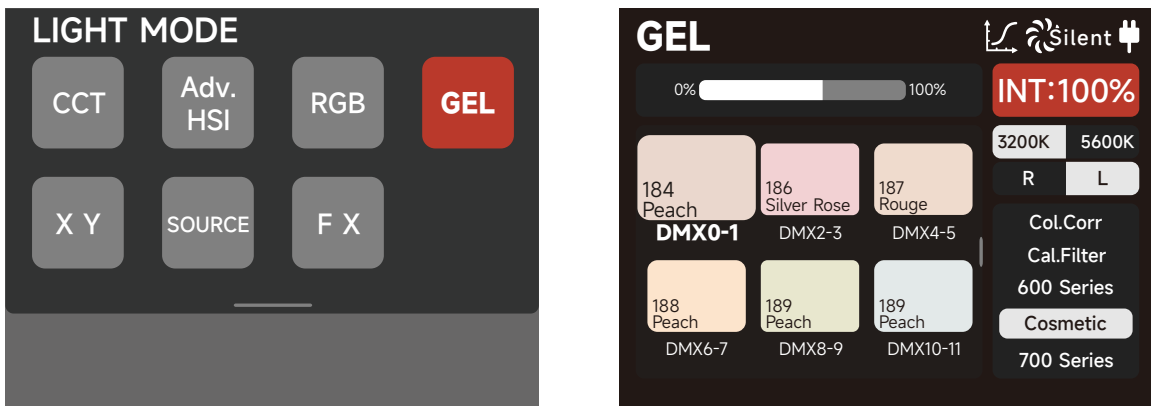

2.1.5 XY

Set the x or y coordinate value (0.0000-0.8000) and Intensity.



2.1.6 Source

Select the light source to mimic and fine tune the xy coordinates.

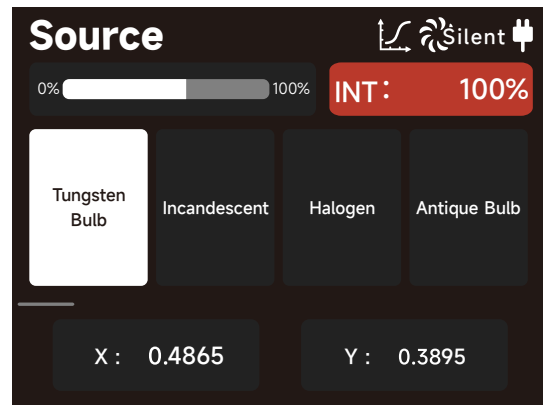
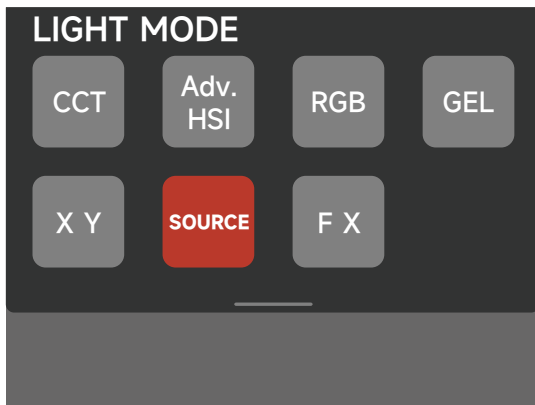

2.1.7 FX

Select between FX modes: Fireworks / Explosions / Flames / Paparazzi / Defective Bulb / TV / Pulse / Party Lights / Club / Color Chase / Candle / Welding / Police Car / Flash / Lightning

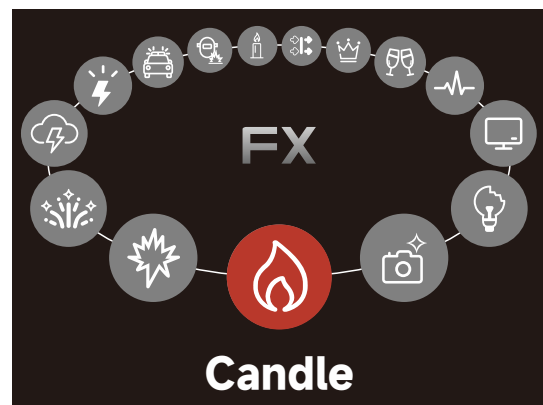
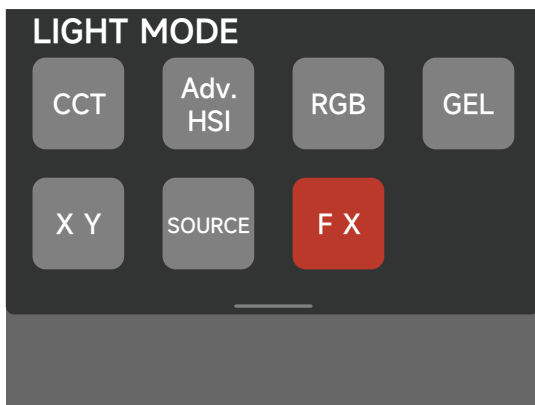

2.2 Settings

Press "MENU" to access the interface of the various settings. Choose between: Output Settings, High-Speed Mode, Dimming Curve, Control System, Studio Mode, Fan Mode, Update, Product Info, Custom FX, Language, Factory Reset, Accessory, Lead/Follow Mode.

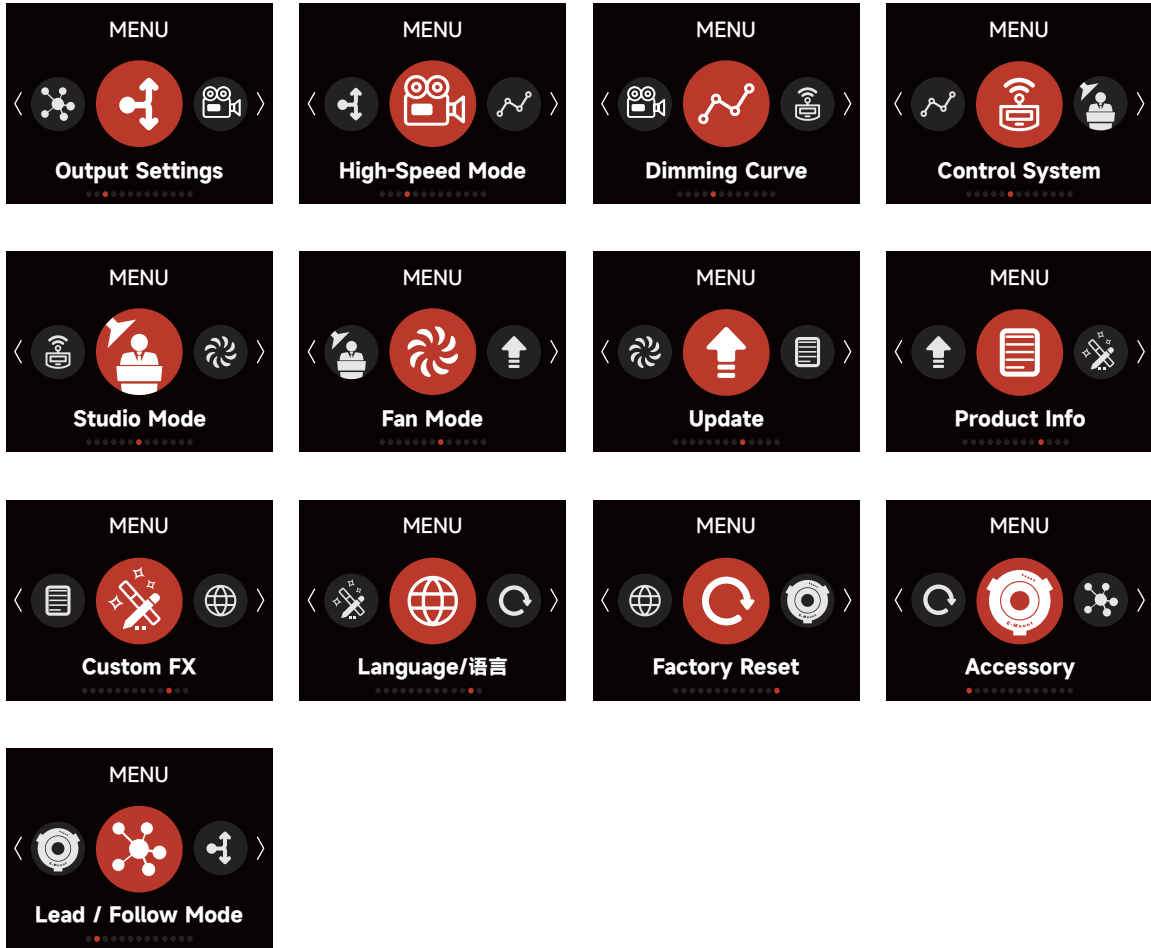

2.2.1 Output Settings

- (1) Constant Output: The lamp's brightness is consistent throughout the color temperature range.
- (2) Max Output: The lamp's brightness is prioritized throughout the color temperature range.

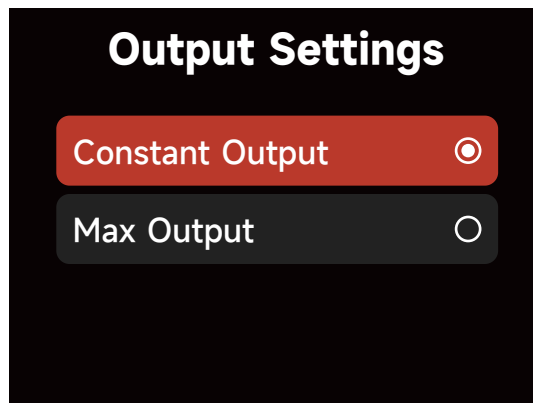

(3) Max Power Settings: When you utilize the indoor power supply cable, this function will be unlocked; you can also release the indoor power supply limitation manually.

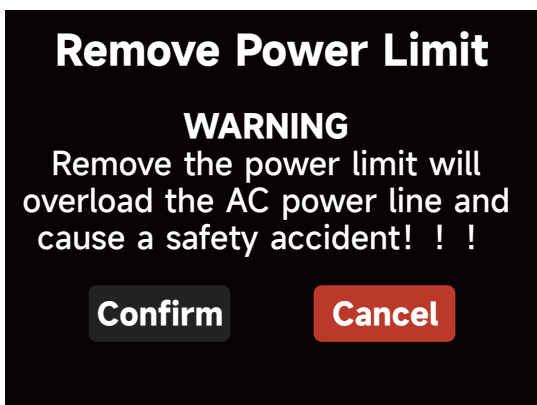
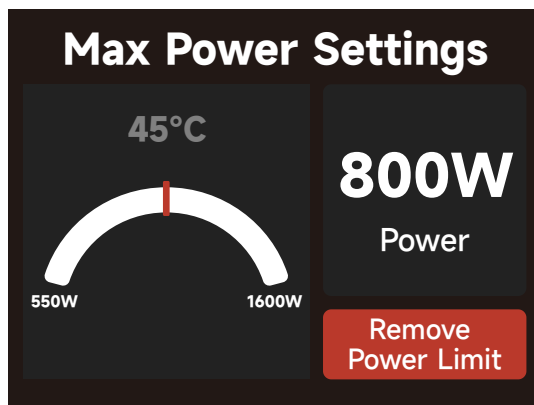
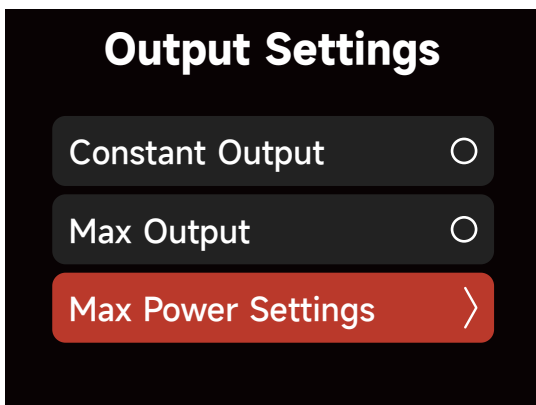

* The indoor power supply is available separately in some regions. When the cable is connected to the power supply, the fixture will automatically match the maximum indoor power in the region where it is applied; the user may release the power limitation in the interface. Please note that selecting this option may lead to an overload of your power supply circuit and bypass safety considerations!

2.2.2 High-Speed Mode

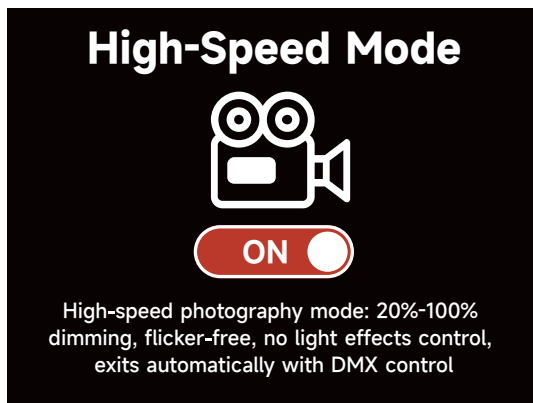
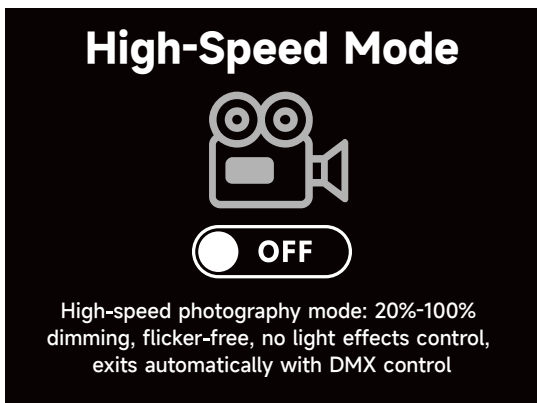

* If you turn on High-Speed Mode:

- (1) The intensity of the lamp is set to a minimum of 20%. No level below 20% is allowed while using High-Speed Mode.
- (2) FX Modes cannot be utilized in High-Speed Mode.
- (3) Controlling the light with DMX data is not allowed in High-Speed mode. If the unit detects DMX data, then High-Speed Mode is automatically disabled.

2.2.3 Dimming Curve

The following Dimming Curves are available: Linear, Logarithmic, S-Curve and Exponential.

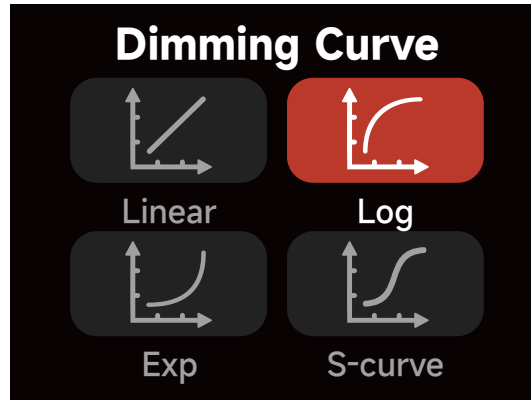

2.2.4 Control System

Electro Storm CS15 is equipped with four remote control options: DMX, Sidus BT, CRMX and Ethernet (Art-Net/sACN). Only one control option can be used at a time.

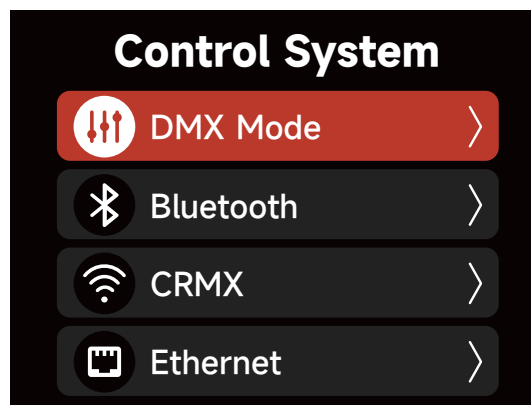

2.2.4.1 DMX

In DMX Mode, you can choose the following options.

- (1) DMX Status Screen—displays information including: DMX Address, CRMX reception strength, DMX Profile in use, the next available address after this light and its accessories total DMX footprint.

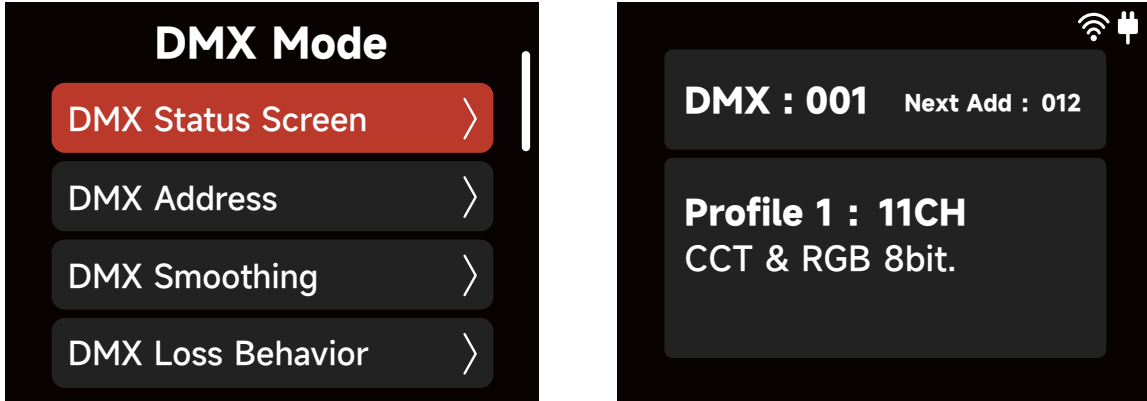

- (2) DMX Address: set the DMX address of the device and long press “Select” to lock the current address and display. Long press the knob again to unlock.

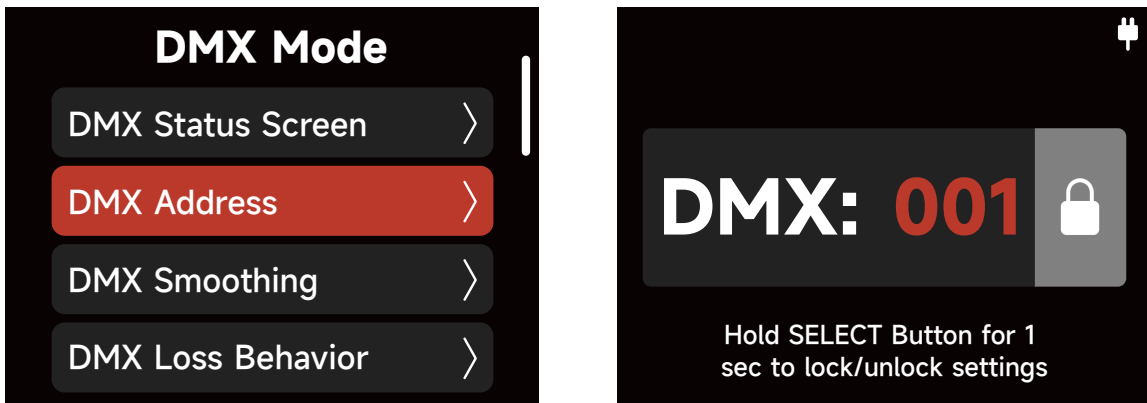

- (3) DMX Smoothing: set the smoothness of DMX dimming. You can choose between Smooth, Extra Smooth and OFF.

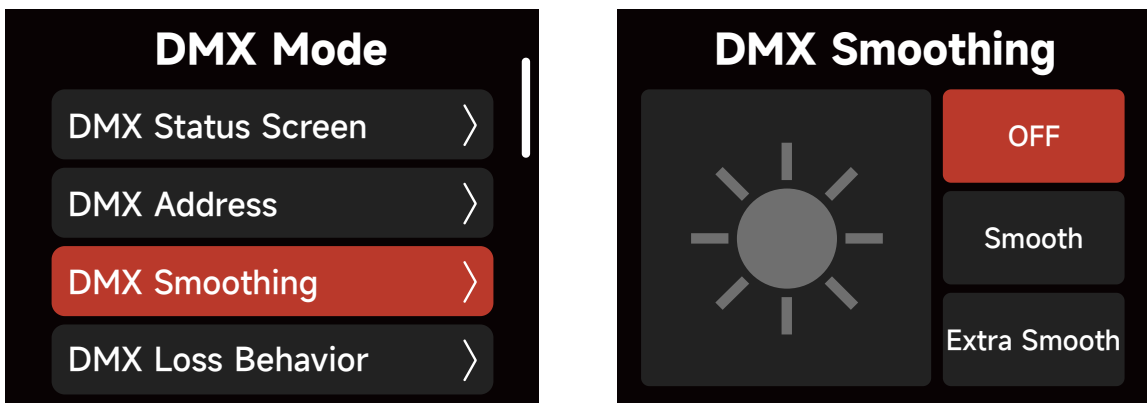

(4) DMX Loss Behavior:

- ① Hold Last Settings – holds the last control levels after the DMX signal is lost;
- ② Black Out – black out after the DMX signal is lost;
- ③ Fade to Black – fade to black over 60 seconds after the DMX signal is lost;
- ④ Hold 2 mins & Fade Out – hold the last control signal for 2 minutes and fade out over 60 seconds after the DMX signal is lost;

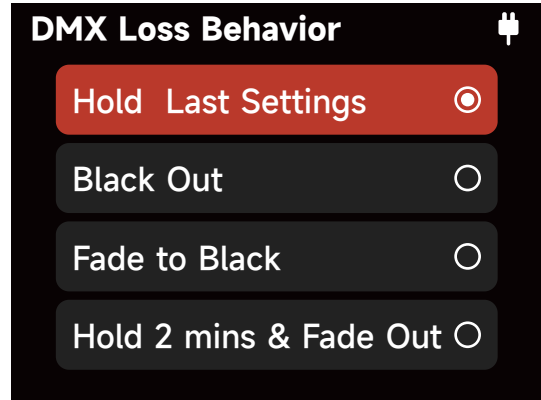
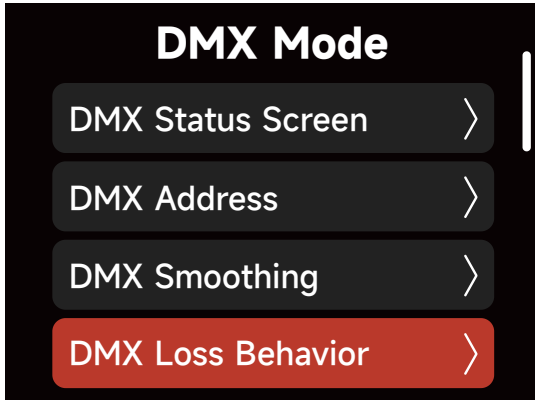

(5) DMX Profile: Refer to the DMX Chart for details.

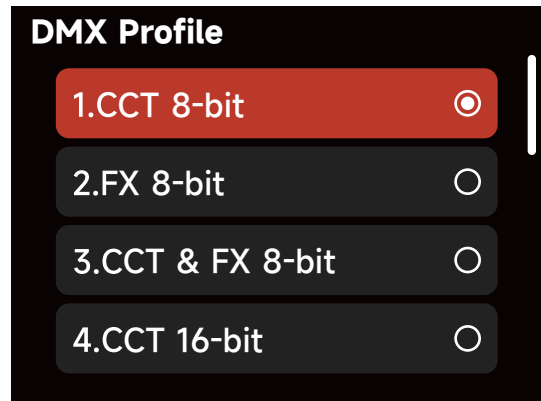
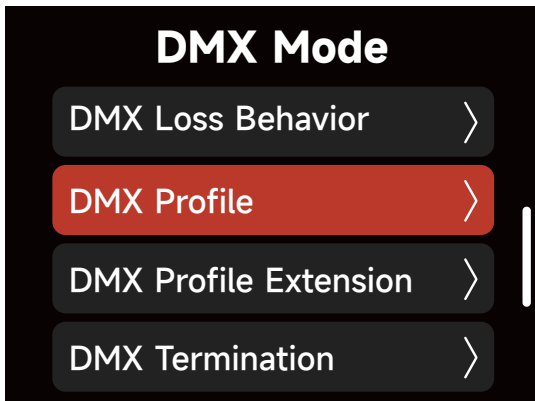

(6) DMX Profile Extension:

Motorized Accessories: When enabled, the required channels for the Motorized F14 Fresnel and the Motorized Yoke are added to the end of the current DMX Profile's footprint. (Enabled by default.)

Function Configuration: When enabled, the required channels for the Fan and Dimming Curve are added after the Motorized Accessories (if enabled) or after the end of the current DMX Profile's footprint.

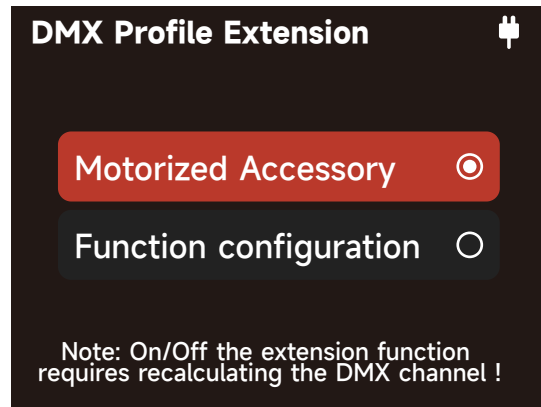
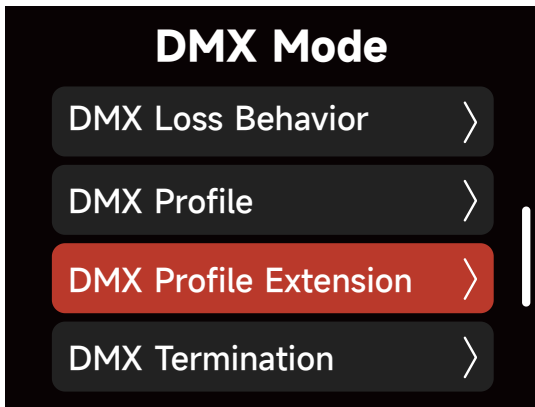

* The motorized F14 Fresnel and the Motorized Yoke are sold separately.

(7) DMX Termination:

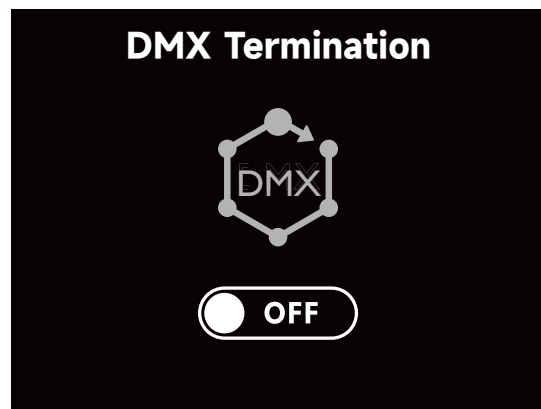
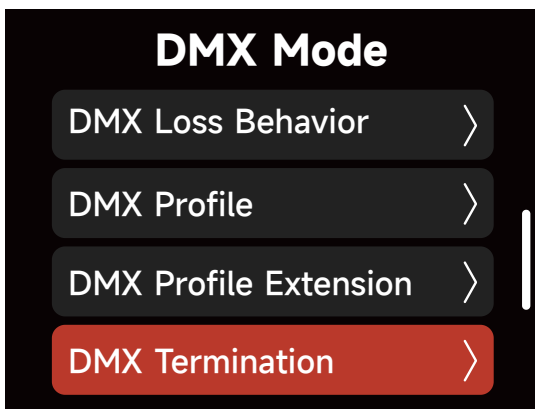

2.2.4.2 Sidus BT

(1) Enable/Disable Sidus Bluetooth. Sidus BT Reset. Sidus BT UID is displayed.

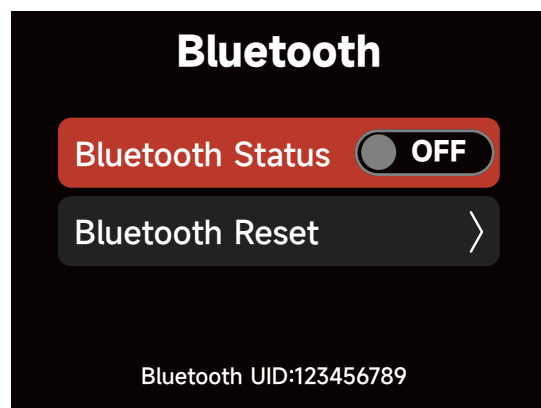
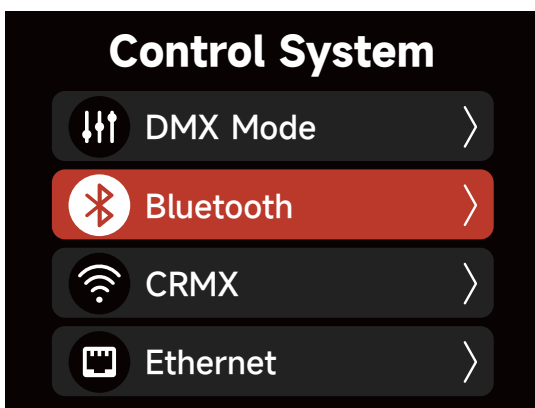

(2) Use Sidus BT Reset to allow your Sidus Link device to connect with a previously paired fixture.
If Sidus BT fails to reset, a "Reset Failed" warning will pop up before returning to the Sidus BT Reset display.

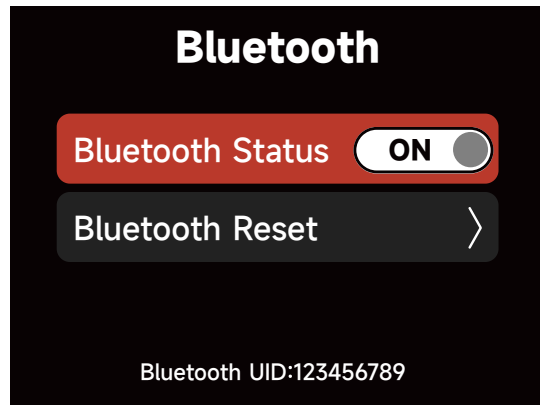
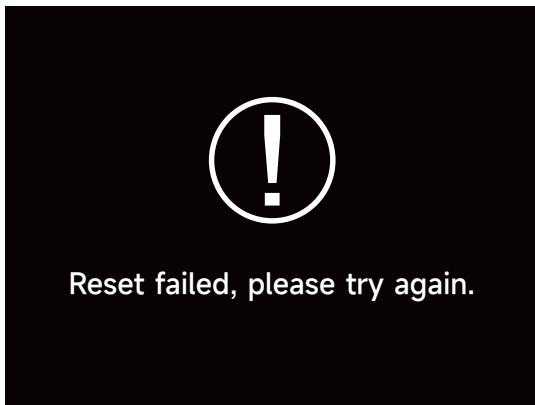
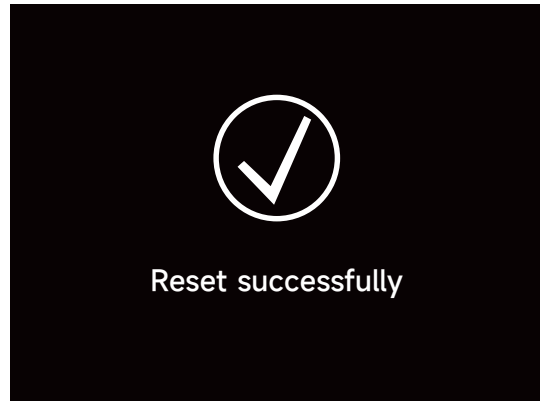
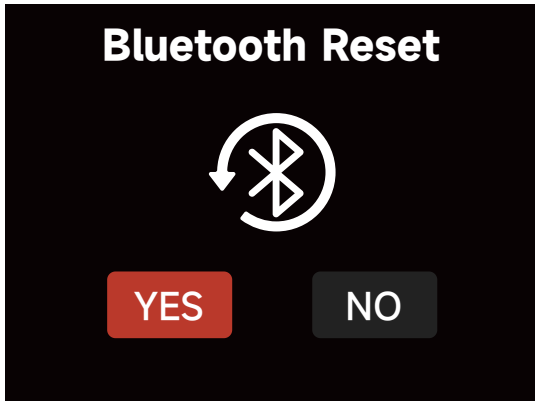

2.2.4.3 CRMX

Users can press the Select knob to turn on/off CRMX.

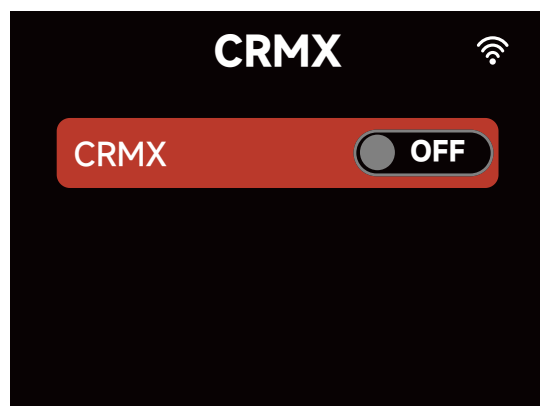
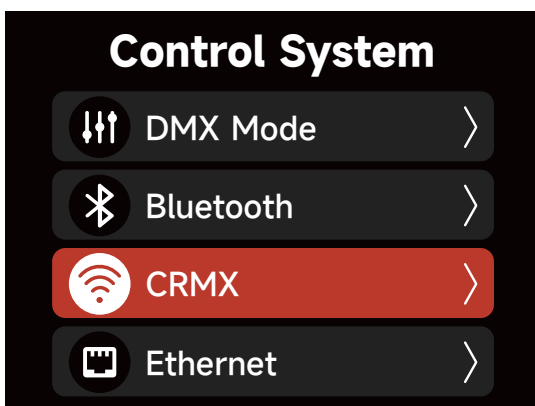

(1) When CRMX is ON/Enabled, the fixture will listen for its previously linked Transmitter. If the fixture is currently unlinked, it will listen for a Transmitter link signal and link to any new CRMX link signal.

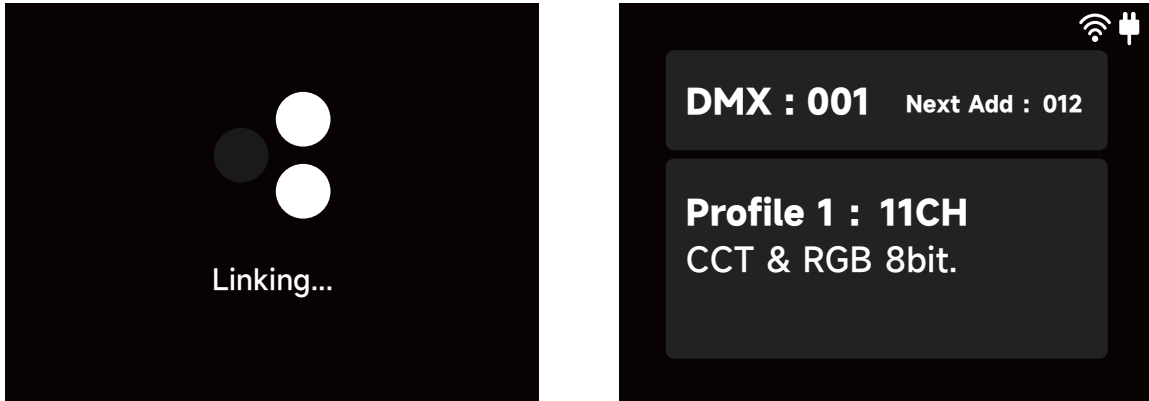

(2) Users can Unlink from previously linked Transmitters by selecting "Unlink".

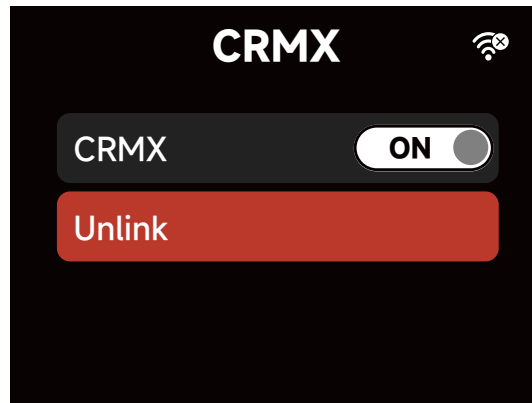

- (3) When the fixture is connected to a CRMX Transmitter, the Control Box will display the connection status and signal intensity of CRMX in the DMX status bar:
- a. Signal intensity: indicates the connection strength between the Control Box and the Transmitter. When the signal intensity is too low, please adjust the distance between the CRMX Transmitter and the Control Box to improve stability.
 - b. Normal status: good connection and data is present.
 - c. No data: The CRMX Transmitter is connected but no data is present.
 - d. No connection: Though the CRMX transmitter was connected before, the transmitter is out of range or is off.

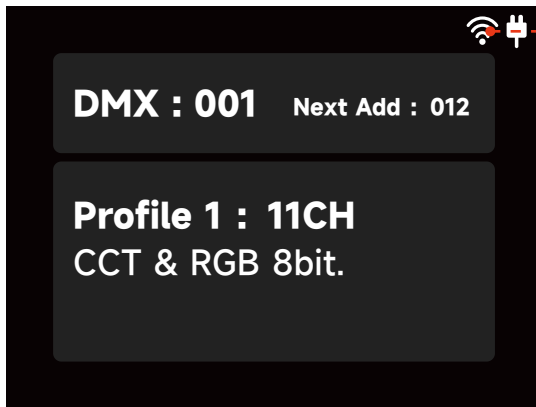

- a. Signal intensity
- b. Receiving CRMX data
- c. Receiving CRMX, but no DMX data is present
- d. Linked, but no TX is present

2.2.4.4 Ethernet

You can set IP and control protocol (Art-Net/sACN) here.

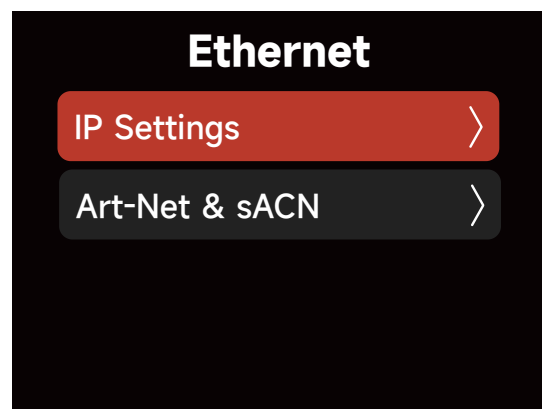
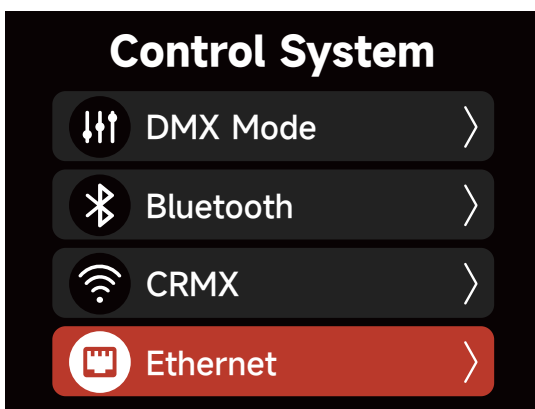

(1) a. Auto Set IP: The fixture will automatically receive an IP address from the DHCP server. In Auto Set IP mode, you cannot edit the IP address, subnet mask and gateway.

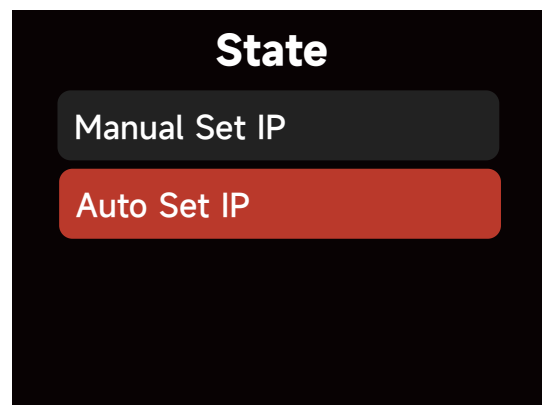
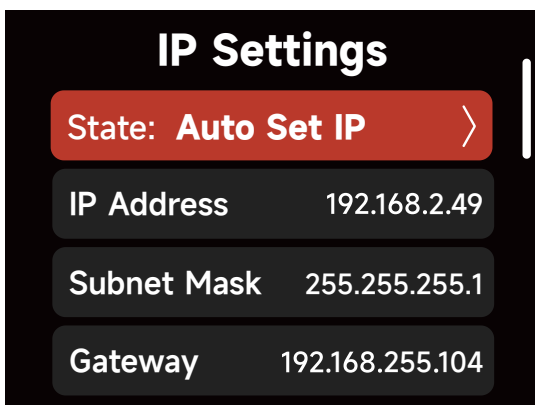

b. Manual Set IP: Manually set the IP address, Subnet Mask and the Gateway IP address.

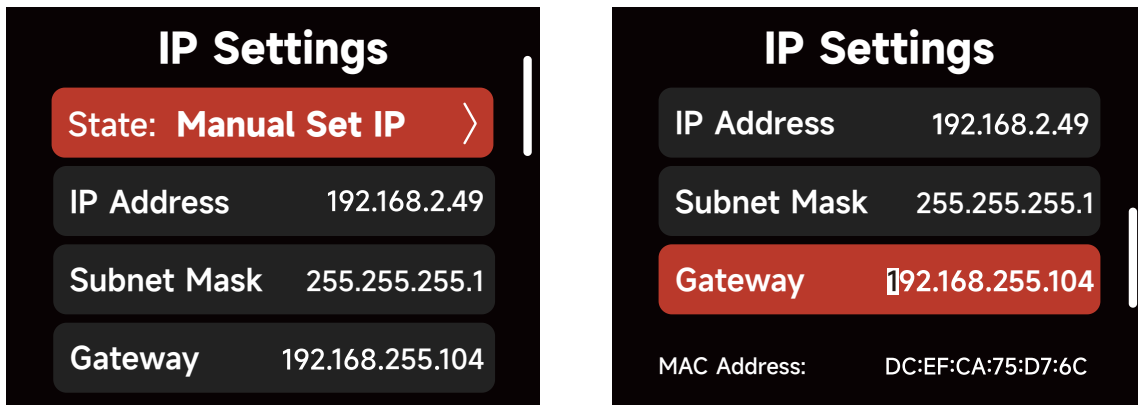

(2) Art-Net & sACN: select which control protocol you are sending over ethernet.

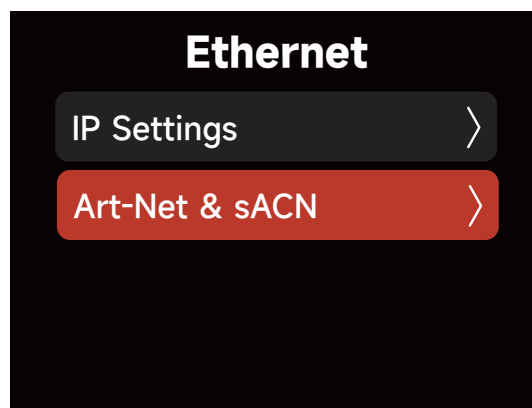

a. Choose between the following:

- (a) Automatic: the Control Box will automatically identify the current Ethernet protocol
- (b) Art-Net Only: use the Art-Net protocol only; the fixture will not respond to the sACN protocol
- (c) sACN Only: use the sACN protocol only; the fixture will not respond to the Art-Net protocol
- (d) OFF: control protocols over ethernet are disabled.

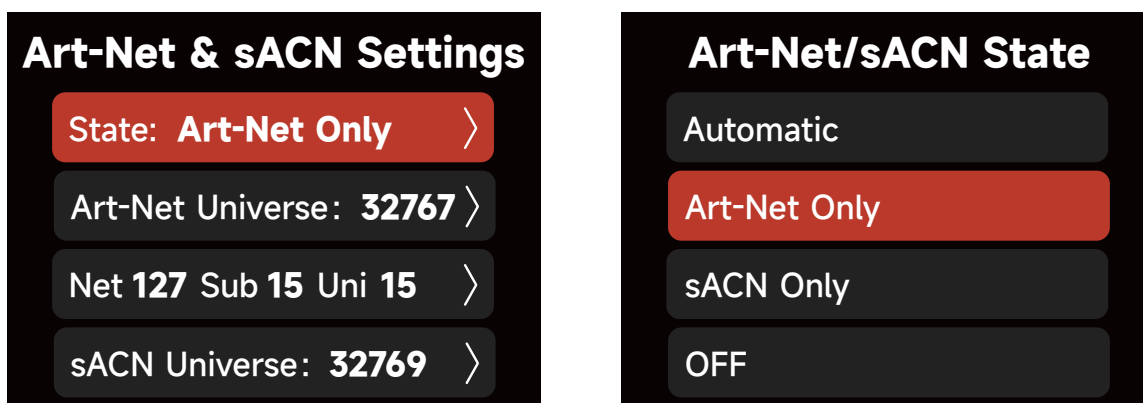

b. Art-Net Universe: set the Art-Net Universe

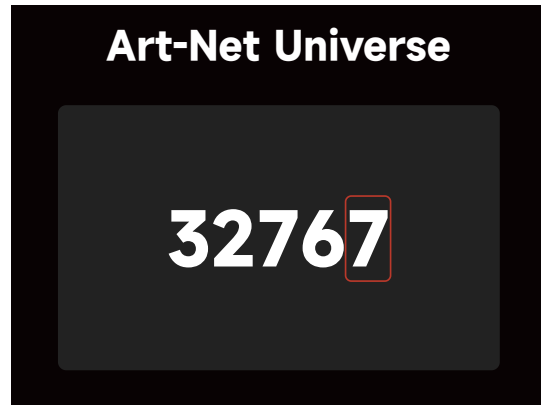
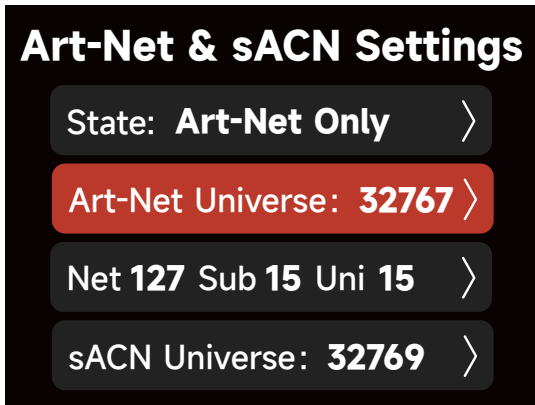

c. Net Sub Uni: set the Art-Net Net, Sub-Net and Universe

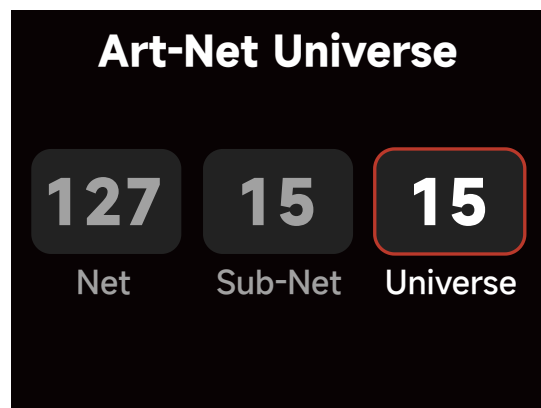
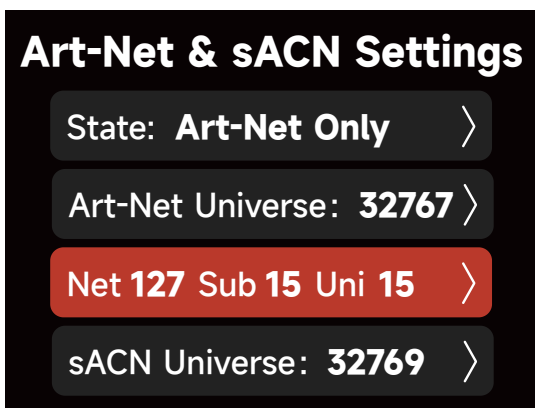

d. sACN Universe: set the DMX universe of sACN

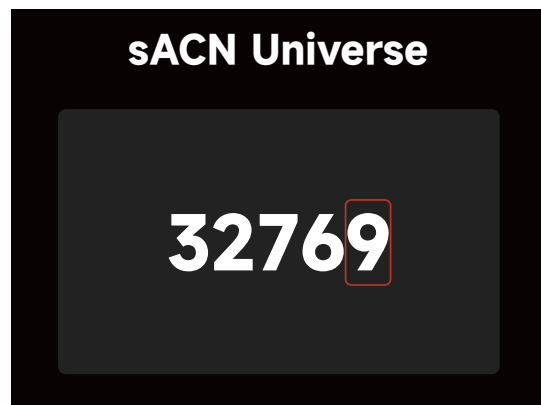
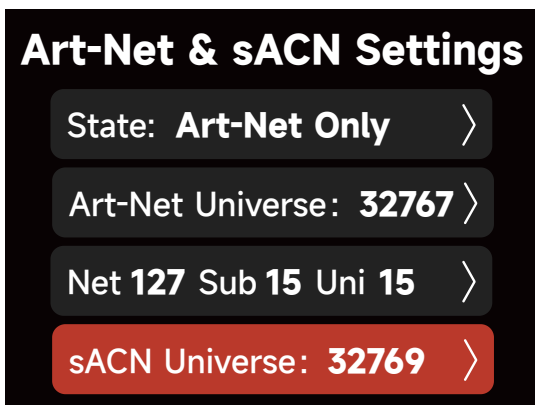

2.2.5 Studio Mode

Press Select to turn ON/OFF Studio Mode. When the studio mode is enabled (ON), the fixture will power on when connected to live power. When studio mode is disabled (OFF), press the power button to power on the fixture.

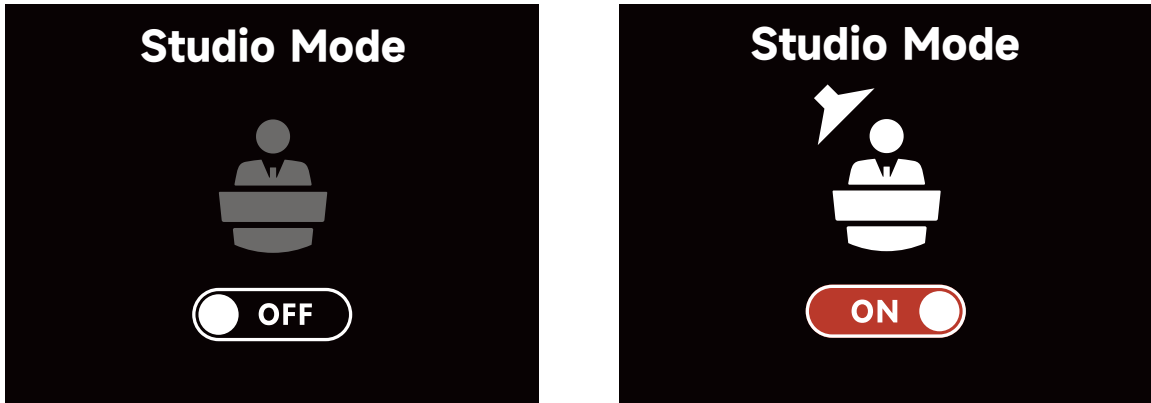

2.2.6 Fan Mode

Rotate the Select Knob to choose between Smart/High/Medium/Silent modes and press the knob to select. If the high-temperature symbol appears in the Control Box display, please change the fan mode to "Smart" or "High" as instructed below. If the internal temperature of the fixture reaches the temperature threshold, the fixture will power off due to over-temperature protection.

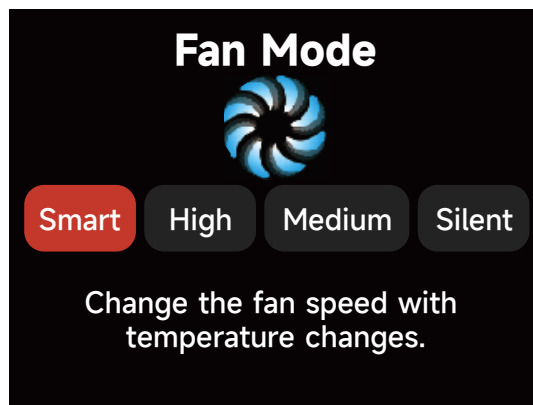

Smart: able to work in -20°C through 45°C environment, the lamp will automatically adjust the fan speed according to different ambient temperatures.

High : able to work in -20°C through 45°C environment, fan will maintain its highest speed. In High-Speed Mode, the fan uses the High Fan setting.

Medium: Capable of working in -20°C through 35° environments, the fan uses a medium speed.

Silent: able to work in -20°C through 45°C environment, the maximum output power of the fixture will be limited to 550w. In this mode, the fan produces the least amount of noise.

2.2.7 Firmware Update

You can upgrade the firmware by inserting a USB flash drive with the latest firmware into the USB port of the control box . The current firmware version is also listed in this interface. NOTE: The fixture can also be updated via Sidus Link with Sidus BT turned ON and a Wi-Fi internet connection on your Sidus Link device.

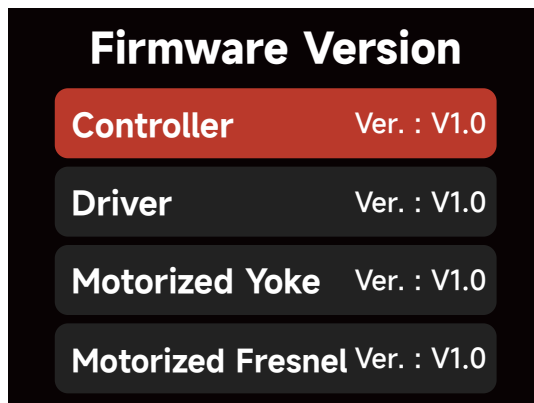
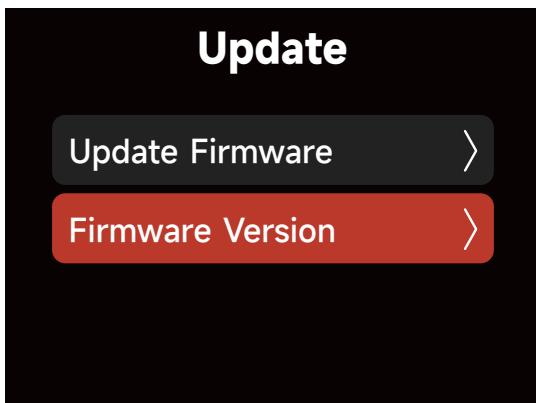
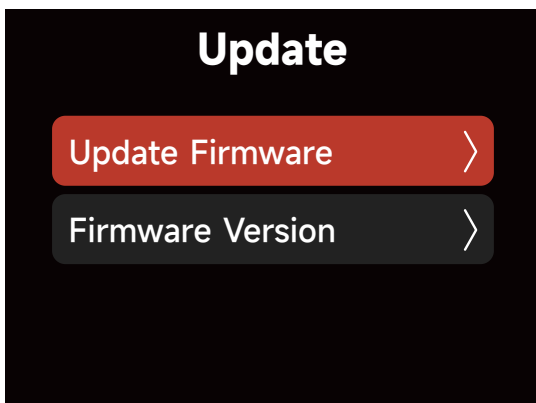

2.2.8 Product Info

The Hardware Version, lamp temperature, Fixture Orientation (when utilizing the Motorized Yoke), and the Fixture Run Time (LED Engine Hours) can all be checked in the Product Info interface.

(1) Hardware Version: display the hardware versions of the Driver and Controller

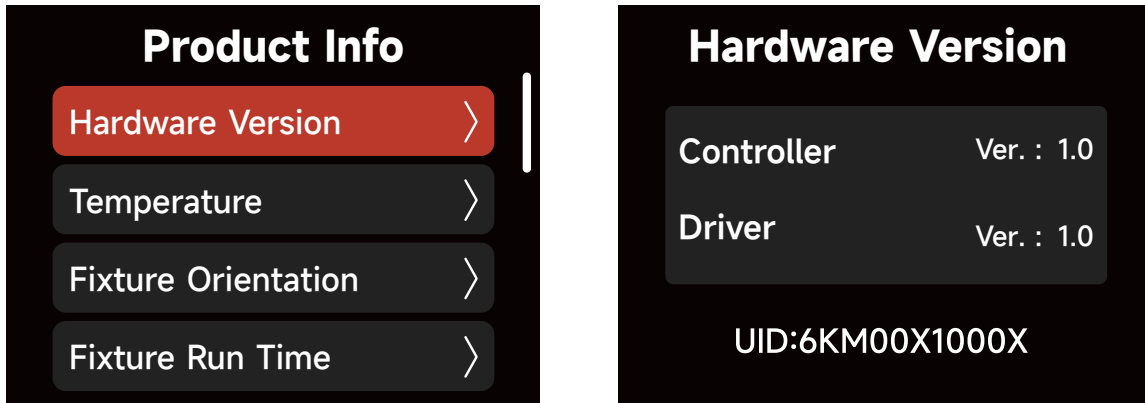

(2) Temperature: Display the LED Temperature, MCU Temperature, and Ambient Temperature

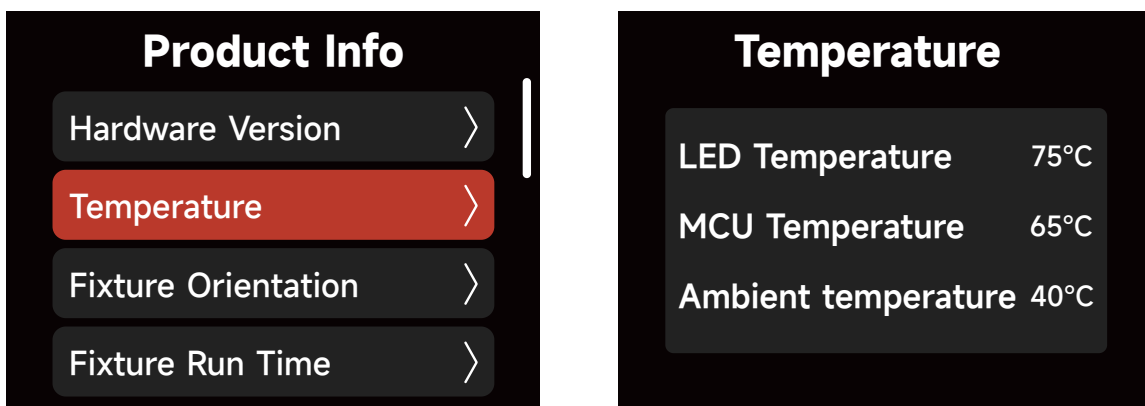

(3) Fixture Orientation: Pan and Tilt

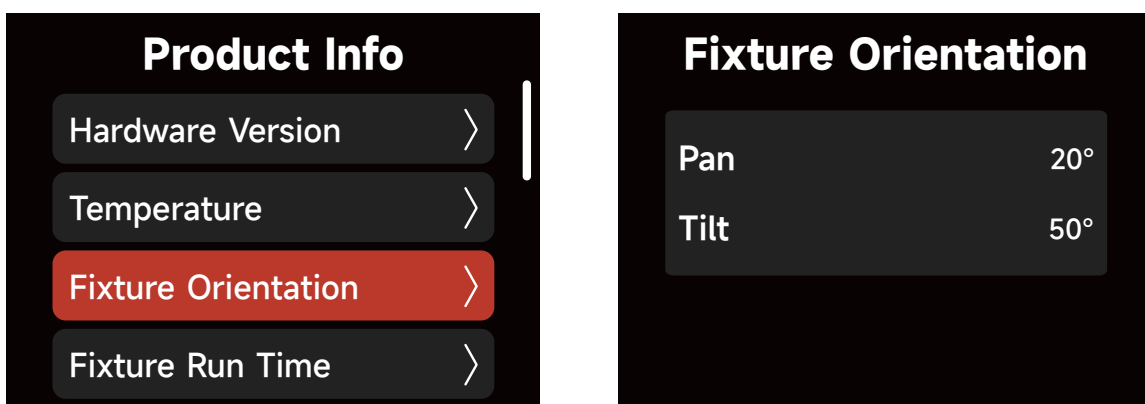

(4) Fixture Run Time: total LED engine hours and total system hours

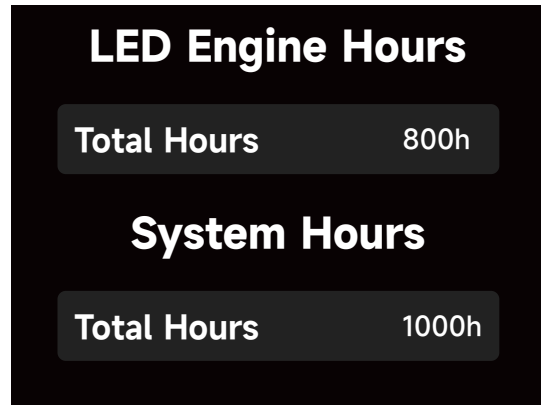
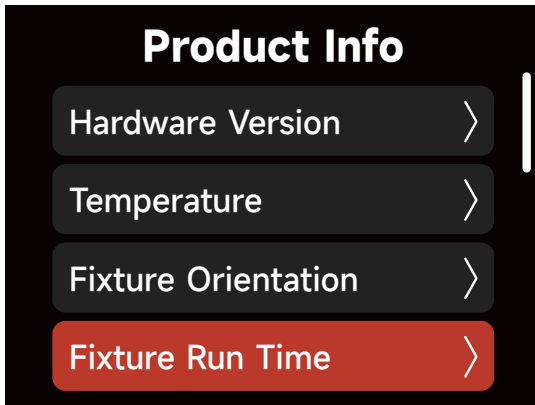

(5) Failure information: If the fixture fails, a pop-up window will appear to indicate an error.

Errors can be divided into two categories:

- a. Serious error: When a serious error occurs, the fixture cannot be used and will be locked for protection. Please respond to the error according to the fault prompt;
- b. General error: When a general error occurs, the fixture is still available and you can choose to ignore the error; then, you can enter the Product Info interface to view the error information.

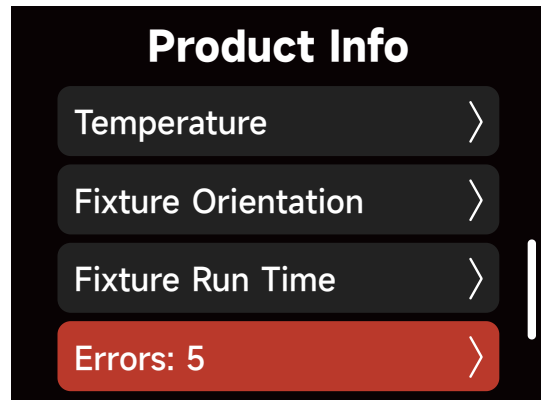
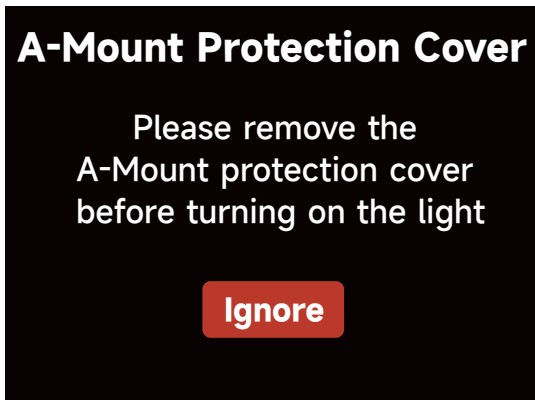

2.2.9 Custom FX

10 custom FXs can be saved for each type of FX. The suffix "NO FX" shows no FX is saved and the suffix "Untitled" shows the FX is saved.

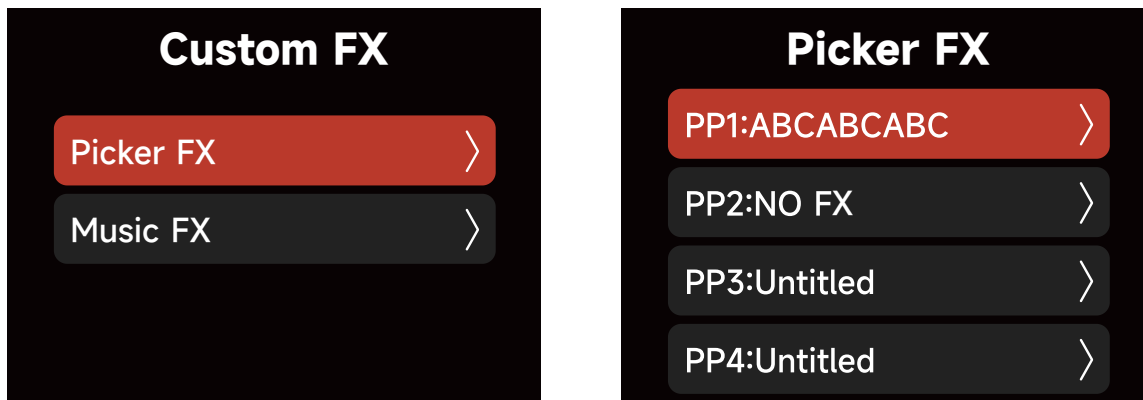

* You can download custom FX by connecting the Sidus Link APP.

2.2.10 Language

Select English or Chinese and press Select for confirmation.

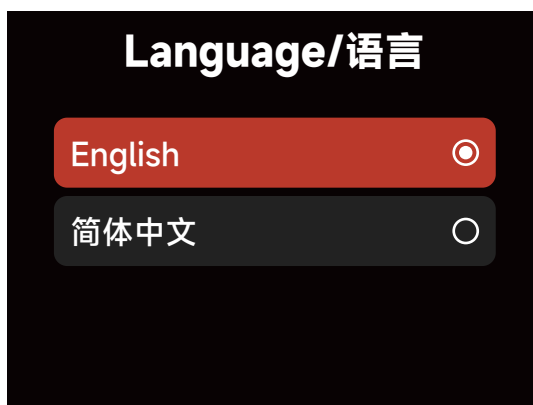

2.2.11 Factory Reset

Select "YES" if you wish to Factory Reset the fixture. Select "NO" to cancel.

You may also long press the Menu button for 3 seconds for a quick Factory Reset shortcut.

Factory Settings:

Light Mode: CCT

Intensity: 50%

CCT: 5600K

Language: English

Fan Mode: Smart

Dimming Curve: Linear

Studio Mode: OFF

Control System: Bluetooth enabled, CRMX disabled

DMX: Channel 001

DMX Loss Behavior: Hold Last Settings

DMX Termination: Off

Sidus BT: ON

CRMX: OFF

CRMX: Unlinked

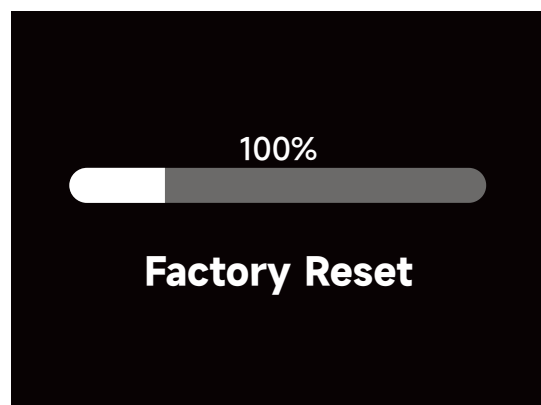

2.2.12 Accessory Control

A Motorized Fresnel, Motorized Yoke, and other Aputure-Mount Accessories can be purchased separately. In the Accessory interface, information about the accessories can be found and settings for the accessories can be adjusted.

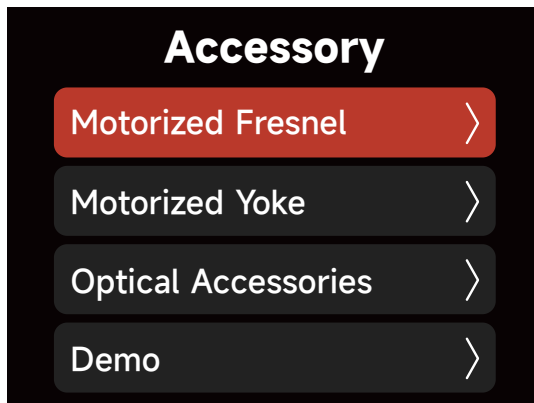

(1) Motorized Fresnel: When the fixture is equipped with the Motorized F14 Fresnel, you can enter this interface to manually adjust the beam angle.

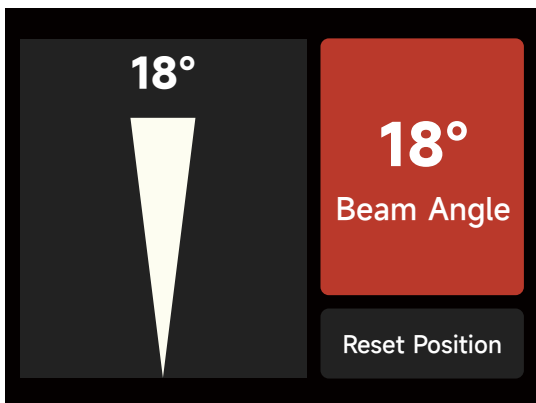
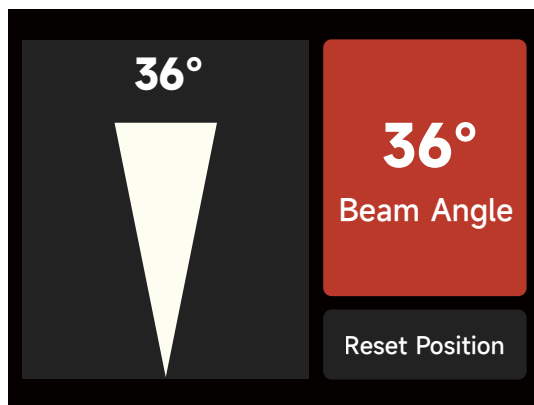
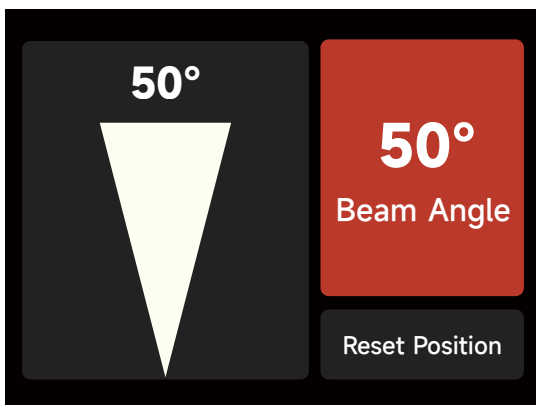

(2) Motorized Yoke: When the fixture is utilizing a Motorized Yoke, the following options are available in the Accessory Motorized Yoke interface:

- a. When also utilizing an Aputure-Mount Accessory, the Motorized Yoke interface will auto-populate motion limitations (pan and tilt) imposed by the Aputure-Mount Accessory.

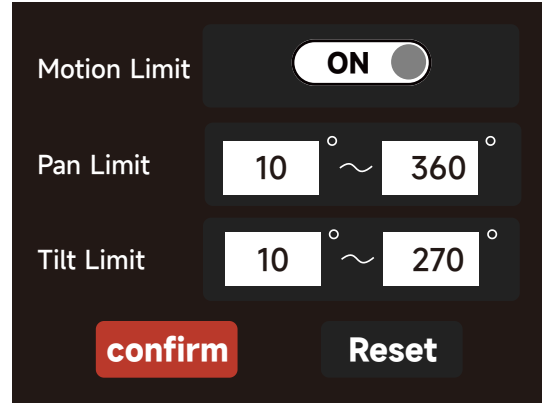
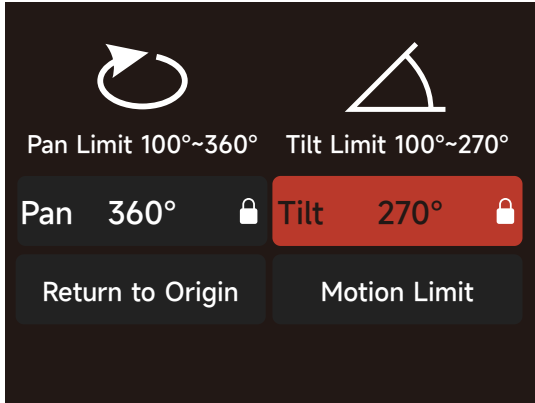

Reset Position: Resets the Motorized Yoke to its home position. Reset Position will also calibrate the motorized yoke.

Motion Limit: Due to differing size and space limitations of your scenario, stricter pan and tilt limitations may be required. Edit and reset motion limits in this interface. Caution is recommended when adjusting and resetting limits.

- b. When using an accessory that does not utilize the Aputure Mount system, the user can manually select the Accessory from the provided list to populate the motion limitations of the Motorized Yoke.

(a) Aputure Bowens mount accessories:

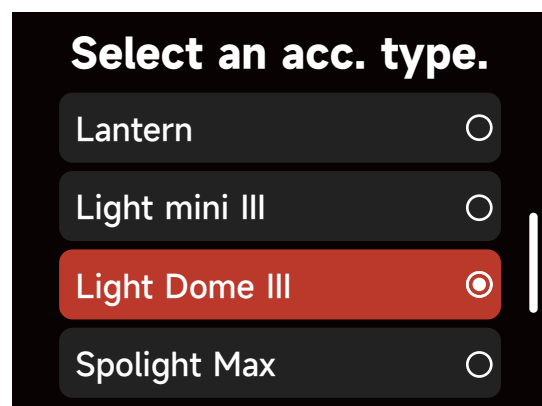
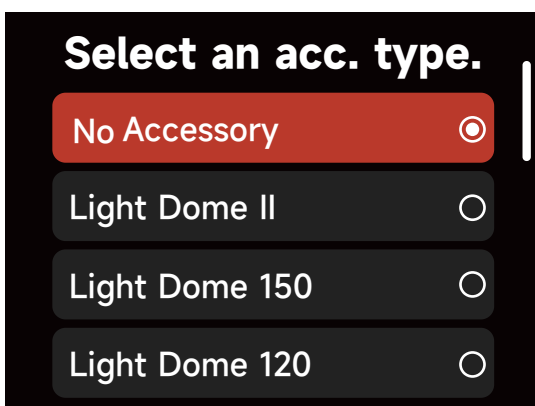

(b) Third-party Bowens mount accessories: When third-party accessories are adopted, you need to configure and manually input the motion limit independently; you may save the accessory after configuration for its application in the future.

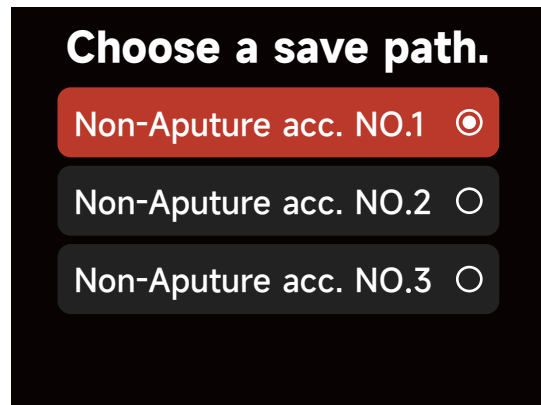
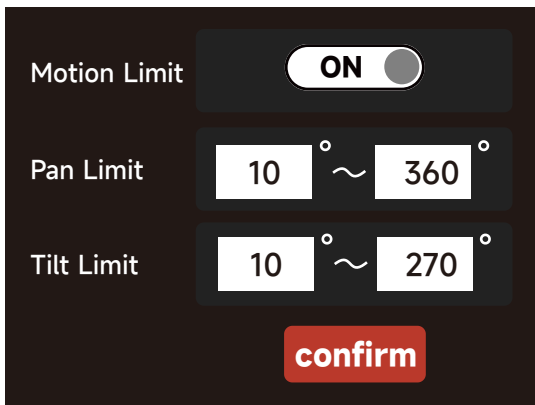
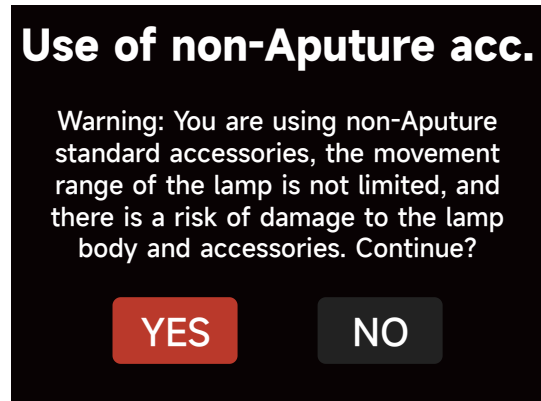
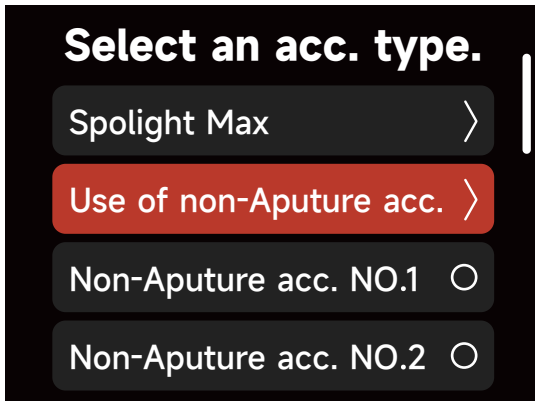

(3) Optical Accessories: When utilizing an Optical Aputure-Mount Accessory, the type of accessory can be viewed in the "Optical Accessories" window. The following accessories are available: narrow-angle standard reflector, medium-angle standard reflector, wide-angle standard reflector and barn door adapter

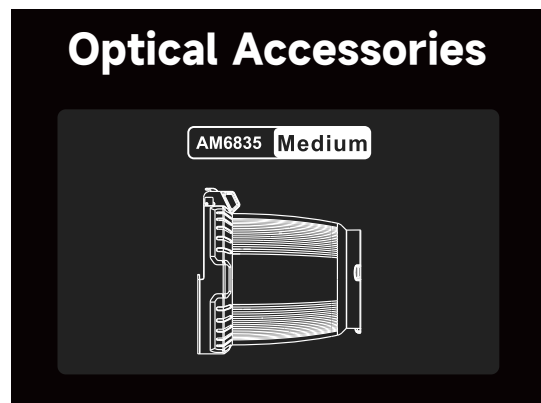
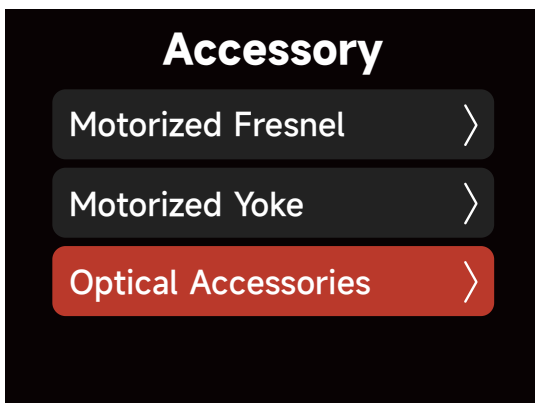

* Narrow Angle Standard Reflector and Wide Angle Standard Reflector sold separately.

2.2.13 Lead/Follow Mode

In this interface, you can set your fixtures as either the Leader or the Follower (Leader/"OFF"). The Leader automatically sends its settings to the Follower fixtures for synchronization. Batch upgrades of the firmware from a USB drive in the Leader's port is also possible.

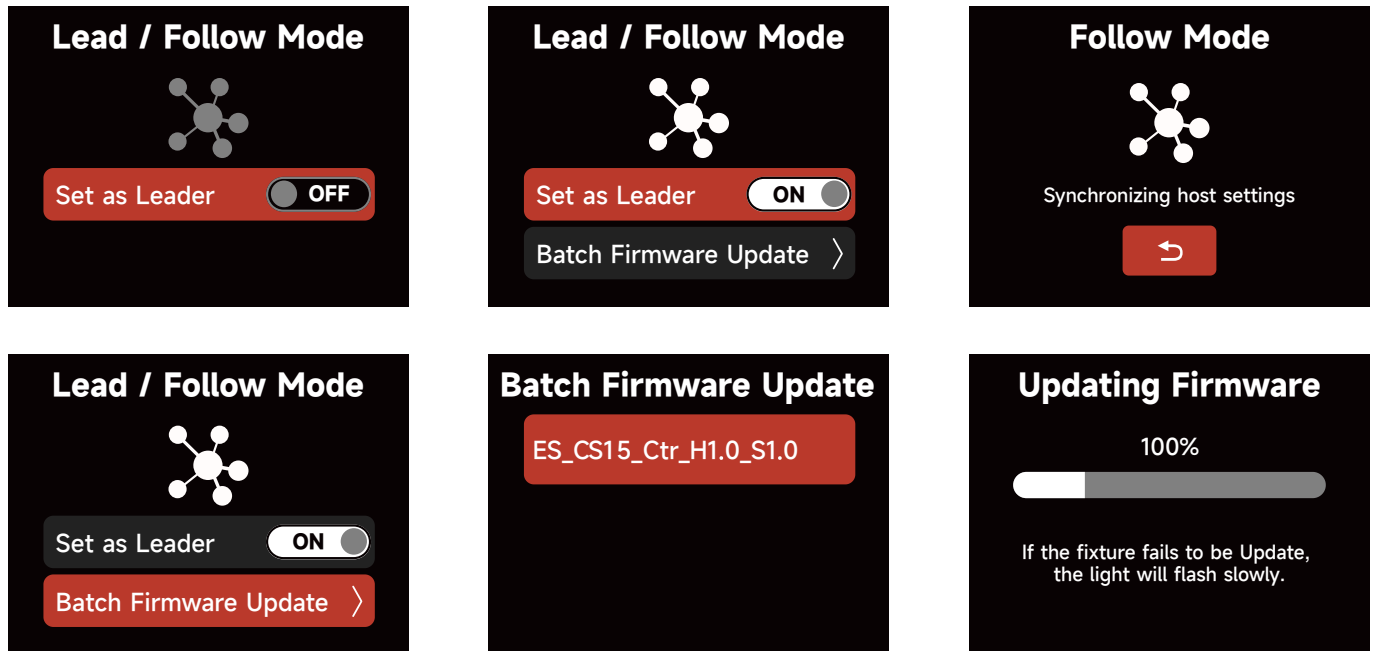

- * *The leader fixture should be connected with the followers via DMX to enable this function*
- * *The USB flash disk containing the up-to-date firmware should be inserted into the Leader fixture to enable batch update*

2.3 Presets

10 Light Mode Presets can be saved.

Choose your settings within the CCT, Adv. HSI, RGB, XY, Source or Gel light modes. Then press the PRESET button to open the Preset interface. Select the Preset number to open, replace or delete the Preset.

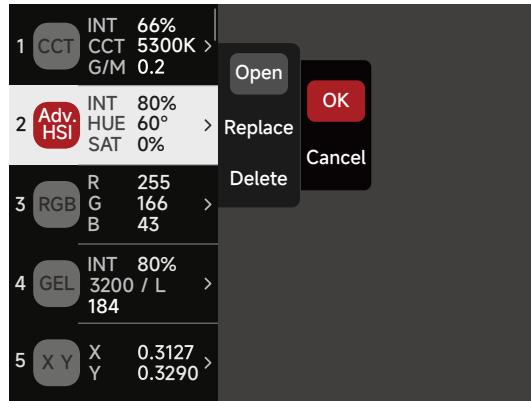

3. Control with DMX Console

3.1 Connect the Lighting Console to the Control Box DMX IN Port

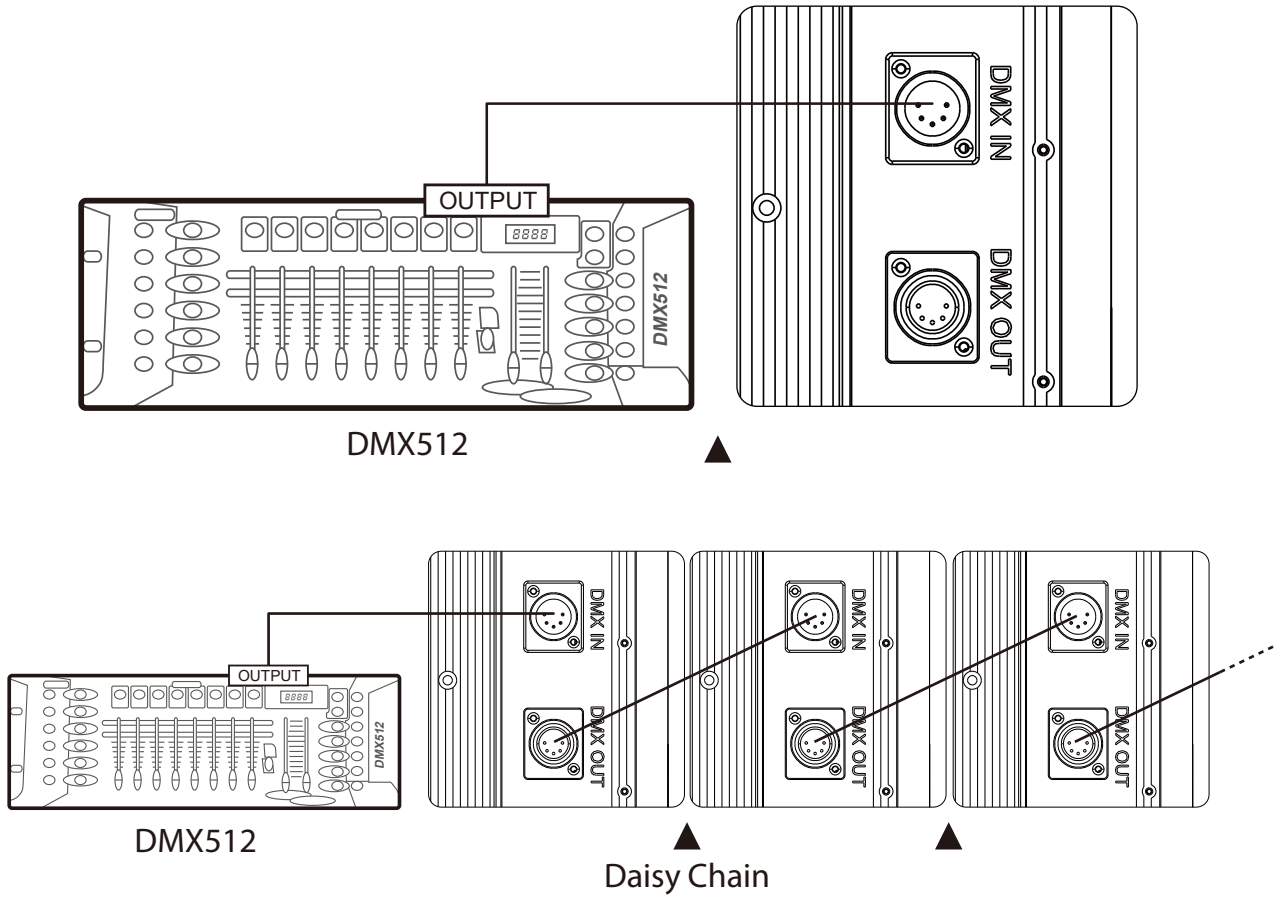

4. DMX Control Operation

Electro Storm CS15 supports several DMX profiles. Please download the DMX channel table on the official website (<https://aputure.cn>) to view detailed configurations.

5. Downloading the Sidus Link APP

You may search Sidus Link in the APP Store or Android market to download the professional control software to control compatible Aputure fixtures. Please access: sidus.link/app/help for detailed instructions



Get Sidus Link[®] App



[Sidus.link/app/help](https://sidus.link/app/help)

Product Specifications

Input power (Max)	2200W	Output power (Max)	1500W
Operating voltage	100 –240 VAC	Operating current	23-9A
CRI	96.5+	TLCI	97+
SSI(D56)	86	SSI(D32)	90
CQS(5600K)	95	CQS(3200K)	97
Color temperature	2000 K – 10000 K	Protection grade	IP65
DC interface 1	48V/19A	DC interface 2	48V/19A
Cooling method	Liquid cooling, fan	Operating temperature	-20°C - 45°C
Control distance of Bluetooth	≤ 100 m	Control distance of CRMX	≤ 100 m

Size (length X width X height)	Lamp without yoke	457*352*281mm
	Lamp with yoke	457*497*684mm
	Control Box	283.5*262*550mm
	CS15 Yoke	591*88*497mm
	Medium-angle standard reflector	306*266*252mm
	Barn doors	282*303*40mm
	Barn doors adapter	303*263*87mm
	AC power cord	6m
	Head cable	15m
	Aputure Mount protection cover	165*165*34mm
	Control Box Dolly	439*470*1054mm(unfolded) 200*470*703mm(folded)

Weight	Lamp (without yoke)	15.2kg
	Control Box	19.5kg
	CS15 Yoke	3.2kg
	Medium-angle standard reflector	1.55kg
	Barn doors	1.6kg
	Barn doors adapter	0.6kg
	AC power cord	0.84kg~1.93kg (may differ due to different specifications)
	Head cable	5.7kg
	Aputure Mount protection cover	0.2kg
	Control Box Dolly	7.22kg

* Lamp failure due to water ingress voids the user warranty.

* If Electro Storm CS15 is used under heavy rain, the use angle of the lamp recommended is shown in the following figure:

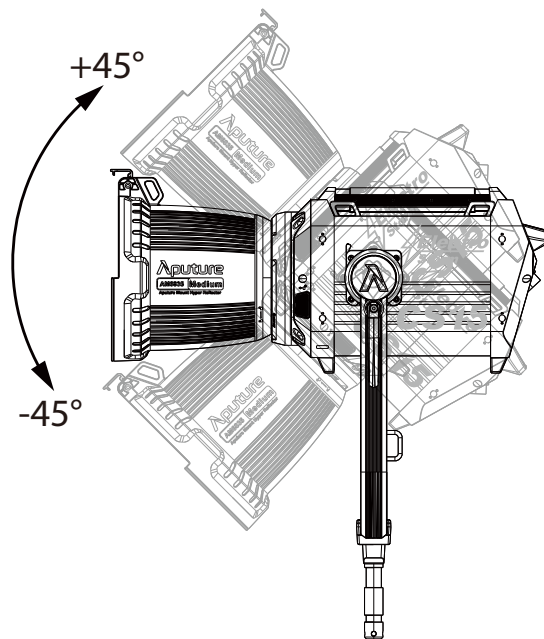

Photometric Data

Distance of 2M	Normal mode (HyperSync)								
	Bare lamp	Reflector at 50°	Reflector at 35°	Reflector at 20°	spot 50°	spot 36°	spot 19°	Fresnel at 18°	Fresnel at 50°
2000K	3710	12170	24060	69600	1584	3370	7080	30000	6810
2700K	8830	30600	60400	173600	3720	8110	17050	73200	17840
3200K	10280	34900	67100	197500	4210	9160	19110	83400	20240
4300K	10840	36800	72300	208700	4500	9620	20140	87200	20700
5600K	11250	38600	75000	218100	4640	10060	20450	90400	21090
6500K	11710	33800	65700	190800	4780	10440	21320	93100	21620
7500K	10510	33800	67700	193200	4210	9270	18970	83300	19260
10000K	10100	33200	66000	187900	4080	8870	18040	79700	18220

Distance of 2M	High-speed photography mode								
	Bare lamp	Reflector at 50°	Reflector at 35°	Reflector at 20°	spot 50°	spot 36°	spot 19°	Fresnel at 18°	Fresnel at 50°
2000K	4360	14160	28400	81400	1856	3970	8190	34700	8120
2700K	8940	30100	60900	174600	3760	8170	16910	72300	18020
3200K	10480	35100	70800	203300	4370	9530	19590	84500	20700
4300K	12500	40800	82200	235100	5170	11210	22860	99600	23850
5600K	12640	39200	78600	226400	5170	11200	22690	99900	23440
6500K	12140	34000	68200	197100	4920	10680	21570	95200	22170
7500K	10730	34200	68600	198300	4320	9390	18920	83800	19400
10000K	10320	33700	67600	195900	4160	9010	18110	80500	18450

Distance of 3M	Normal mode (HyperSync)								
	Bare lamp	Reflector at 50°	Reflector at 35°	Reflector at 20°	spot 50°	spot 36°	spot 19°	Fresnel at 18°	Fresnel at 50°
2000K	1818	5310	10340	30100	762	1640	3150	14400	3410
2700K	4330	13270	25730	76300	1801	3880	7660	34900	8870
3200K	5040	15210	28880	85400	2060	4400	8840	40200	10100
4300K	5210	15980	31100	91800	2131	4670	9150	42200	10380
5600K	5540	16740	32600	94500	2200	4830	9260	43800	10590
6500K	5650	14670	28600	83900	2282	4950	9600	45100	10850
7500K	5140	14850	28100	84700	2032	4450	8580	40300	9710
10000K	4870	14420	27500	82400	1938	4210	8150	38500	9180

Distance of 3M	High-speed photography mode								
	Bare lamp	Reflector at 50°	Reflector at 35°	Reflector at 20°	spot 50°	spot 36°	spot 19°	Fresnel at 18°	Fresnel at 50°
2000K	2133	6220	12090	35200	894	1927	3760	17440	4120
2700K	4360	13340	25960	75700	1822	3920	7790	36100	9080
3200K	5110	15520	30000	88000	2109	4580	9020	42100	10460
4300K	6110	18030	34800	102200	2481	5410	10610	49900	12030
5600K	6170	17320	33200	97800	2472	5400	10440	50000	11860
6500K	5900	14960	28900	84900	2354	5150	9930	47700	11220
7500K	5230	15030	29000	85300	2065	4530	8700	42000	9810
10000K	5030	14810	28600	84000	1980	4350	8320	40300	9350

Distance of 5M	Normal mode (HyperSync)								
	Bare lamp	Reflector at 50°	Reflector at 35°	Reflector at 20°	spot 50°	spot 36°	spot 19°	Fresnel at 18°	Fresnel at 50°
2000K	712	2034	3710	10450	300	633	1195	5840	1418
2700K	1680	5070	9260	26450	670	1476	2840	14150	3680
3200K	1827	5760	10610	30100	781	1705	3260	16270	4200
4300K	2056	6120	11080	31600	824	1787	3350	17060	4310
5600K	2143	6420	11650	33100	853	1824	3470	17750	4410
6500K	2227	5630	10220	29100	881	1895	3590	18270	4500
7500K	1967	5650	10170	29500	802	1701	3130	16380	4010
10000K	1911	5530	10050	28600	752	1622	3020	15690	3800

Distance of 5M	High-speed photography mode								
	Bare lamp	Reflector at 50°	Reflector at 35°	Reflector at 20°	spot 50°	spot 36°	spot 19°	Fresnel at 18°	Fresnel at 50°
2000K	829	2388	4390	12330	348	742	1388	7010	1704
2700K	1685	5080	9370	26400	692	1507	2869	14410	3750
3200K	1974	5910	10870	30700	804	1745	3300	16810	4320
4300K	2354	6860	12570	35600	949	2058	3860	19900	4980
5600K	2377	6580	12030	34200	949	2058	3820	19930	4920
6500K	2272	5720	10440	29700	906	1963	3640	19060	4640
7500K	2012	5740	10480	29780	795	1705	3220	16770	4070
10000K	1936	5640	10320	29320	764	1658	3060	16080	3870

Distance of 7M	Normal mode (HyperSync)								
	Bare lamp	Reflector at 50°	Reflector at 35°	Reflector at 20°	spot 50°	spot 36°	spot 19°	Fresnel at 18°	Fresnel at 50°
2000K	350	1039	1842	5220	151	316	607	3090	791
2700K	822	2580	4580	13140	357	757	1477	7430	1956
3200K	948	2940	5250	14990	394	876	1687	8540	2230
4300K	1004	3160	5540	15720	425	920	1761	8990	2320
5600K	1049	3300	5810	16560	441	957	1809	9350	2392
6500K	1082	2902	5090	14480	455	985	1865	9650	2452
7500K	976	2940	5140	14650	406	883	1682	8640	2180
10000K	935	2827	5010	14250	389	845	1550	8250	2077

Distance of 7M	High-speed photography mode								
	Bare lamp	Reflector at 50°	Reflector at 35°	Reflector at 20°	spot 50°	spot 36°	spot 19°	Fresnel at 18°	Fresnel at 50°
2000K	410	1220	2163	6140	178	378	717	3620	940
2700K	828	2606	4610	13140	357	768	1478	7480	1973
3200K	968	3010	5370	15320	416	911	1713	8750	2289
4300K	1154	3490	6220	17790	492	1059	2006	10410	2674
5600K	1165	3370	5950	17010	493	1060	1989	10470	2651
6500K	1106	2900	5170	14740	471	1012	1891	10030	2519
7500K	987	2920	5200	14800	414	893	1659	8840	2208
10000K	947	2880	5120	14580	397	856	1587	8530	2115

* The brightness data are average values and the brightness of different lamps may vary slightly.

Safety Instructions

When using this product, basic safety precautions should always be followed, including:

1. Read and understand all instructions before using the fixture.
2. Close supervision is necessary when any fixture is used by or near children. Do not leave the fixture unattended while in use.
3. Care must be taken as burns can occur from touching hot surfaces.
4. Do not operate the fixture if any cord is damaged, or if the fixture has been dropped or damaged, until it has been examined by qualified service personnel.
5. Position any power cables such that they will not be tripped over, pulled, or put into contact with hot surfaces.
6. If an extension cord is necessary, a cord with an amperage rating at least equal to that required by the fixture should be used. Cords rated for less amperage will overheat.
7. Always unplug the lighting fixture from the electrical outlet before cleaning and servicing, or when not in use. Never yank the cord to remove the plug from the outlet.
8. Let the lighting fixture cool completely before storing. Unplug the cables from the lighting fixture and store them in assigned spaces of the carrying case (if being used).
9. Do not immerse this fixture in water or any other liquid to avoid electric shock.
10. Do not disassemble the fixture to avoid the risk of fire or electric shock. Contact cs@aputure.com or take the lighting fixture to qualified service personnel when service or repair is required. Incorrect reassembly may cause electric shock when the lighting fixture is in use.
11. Using any accessory attachment not recommended by the manufacturer may increase the risk of fire, electric shock or injury to any persons operating the fixture.
12. Power this fixture by connecting it to a grounded outlet.
13. Remove the Protective Cover before use.
14. Do not block the ventilation openings or look at the LED light source directly when it is powered on.
Do not touch the LED light source in any condition.
15. Do not place the product near combustible and volatile solvents to avoid product damage.
16. Use a soft and dry cloth to clean the device.
17. Ensure all the ports and plugs are completely dry when using the fixture in wet environments to avoid short circuit or electric shock.



18. Service and maintenance should only be carried out by authorized service personnel. Any malfunctions caused by unauthorized disassembly are not covered by the warranty. The user may pay for service and maintenance.
19. When hanging the fixture overhead, always ensure an extra safety measure has been attached -such as safety chains- that is certified for the weight of the fixture. We recommend only using the original Aputure cable accessories. Please note that any malfunctions caused by using unauthorized accessories are not covered by the warranty. The user may pay for service and maintenance. When hanging the fixture overhead, always ensure an extra safety measure has been attached -such as safety chains- that is certified for the weight of the fixture.
20. This product is certified by RoHS, CE, KC, PSE, and FCC. Please operate the product in full compliance with relevant country's standards. Any malfunctions caused by incorrect use are not covered by the warranty. The user may pay for service and maintenance.
21. The User's Manual was formulated based on rigorous tests performed by the Company. No further notice will be given in the event of any change in its design and specifications.

FCC Declaration of Conformity

WARNING

Changes or modifications to this product that are not expressly approved by the manufacturer are prohibited and voids the user warranty.

ATTENTION

This equipment has been tested and found to comply with the limits for a Class B digital device, pursuant to Part 15 of the FCC Rules. These limits are designed to provide reasonable protection against harmful interference in a residential installation. This equipment generates, uses, and can radiate radio frequency energy and, if not installed and used in accordance with the instructions, may cause harmful interference to radio communications. However, there is no guarantee that interference will not occur in a particular installation.

If this equipment does cause harmful interference to radio or television reception, which can be determined by turning the equipment off and on, the user is encouraged to try to reorient or relocate the receiving antenna.

- Increase the separation between the equipment and receiver.
- Plug the device into the socket of a different circuit than the socket that the receiver is plugged into.
- Consult the dealer or experienced radio/TV technician for assistance.

RF Statement

This device has been evaluated to meet general RF exposure requirements.

Disclaimer

Please read the Product Manual before usage to ensure that you have fully understood the instructions and can correctly operate the device. After your reading, please keep the Product Manual properly for reference in the future. If you fail to operate the product correctly, you may get injured seriously or harm others seriously, or damage the product and result in your property damage. Your operation of the product will be deemed that you have understood, recognized and accepted all clauses and content of this document. Users undertake to be responsible for their behaviors and the consequences accordingly. Aputure will not be responsible for all losses arising from users' operation of this product not in accordance with the User's Manual.

The Company reserves the right for the final explanation of this document and all documents relating to the product on the premise of compliance with laws and regulations. No further notice will be given in the event of any update, revision or termination. Please access the official website of Aputure for the up-to-date product information.