

FEELWORLD®

L4

5-CH Multi Format Video Switcher



User Manual

Thank you for choosing our product!

This User Manual is designed to show you how to use this video switcher quickly and make use of all the features. Please read all directions and instructions carefully before using this product.

Safety Instruction

The general safety information in this summary is for operating personnel.

1. There are no user-serviceable parts within the unit. Removal of the top cover will expose dangerous voltages. To avoid personal injury, do not remove the top cover. Do not operate the unit without the cover installed.
2. Please do not use chemical solutions to clean this product. Please wipe the switcher with a clean soft cloth to maintain the brightness of the surface.
3. This product comes with standard 12V/3A power adapter, please use the power supply correctly.
4. To avoid explosion, do not operate this product in an explosive atmosphere.

Installation Safety Summary

Safety Precautions

For all product installation procedures, please observe the following important safety and handling rules to avoid damage to yourself and the equipment. To protect users from electric shock, ensure that the chassis connects to earth via the ground wire provided in the AC power Cord. The AC Socket-outlet should be installed near the equipment and be easily accessible.

Unpacking and Inspection

Before opening product shipping box, inspect it for damage. If you find any damage, notify the shipping carrier immediately for all claims adjustments. As you open the box, compare its contents against the packing slip. If you find any shortages, contact your sales representative. Once you have removed all the components from their packaging and checked that all the listed components are present, visually inspect the system to ensure there was no damage during shipping. If there is damage, notify the shipping carrier immediately for all claims adjustments.

Site Preparation

The environment in which you install your product should be clean, properly lit, free from static, and have adequate power, ventilation, and space for all components.

Contents

Chapter 1 Your Product	3
1.1 Product Overview	3
1.2 Key Features	3
1.3 Front Panel Instruction.....	4
1.4 Interface Panel Instruction	5
Chapter 2 Install Your Product	6
2.1 Plug in Power	6
2.2 Connect Signal Source Input	6
2.3 Connect HDMI and SDI Output.....	7
2.4 Connecting Microphone and External Monitoring Devices	7
2.5 Connect USB3.0 as a Network Signal Source	8
2.6 Connect Computer and L4	8
2.7 Connect USB2.0 for Firmware Update	9
Chapter 3 Use Your Product	10
3.1 Touch Screen	10
3.2 Button Instruction	10
3.3 Menu Operation Instruction	10
3.4 Switch Source	15
Chapter 4 Streaming	16
4.1 OBS Streaming	16
4.2 vMix Streaming	20
Chapter 5 Feelworld Live Plus Software Operation	23
5.1 Connect L4 and computer	23
5.2 Using Feelworld Live Plus (MAC version)	25
Chapter 6 Product Parameters	34

Chapter 1 Your Product

1.1 Product Overview

FEELORLD L4 is a multi-camera video switcher with 4 HDMI and 1 SDI inputs, meet more professional needs. The audio supports MIC and LINE IN, you can choose any 2 for mixing from the 5 input audio sources and external audio.

L4 has a 10.1-inch full color touch screen control, displaying all signal sources and operating interfaces, making the operation of chroma key, PIP, audio smoother and convenient, provide easier live streaming solution. L4 also supports desktop operating systems for Windows and MAC, as well as mobile control for iOS and Android.

1.2 Key Features

- ◆ 10.1-inch touchscreen, real-time preview 5 input sources +PST + PGM and operation interface
- ◆ Iconized touch operation, fast to learn; or buttons + knob operation
- ◆ Compatible with HDMI and SDI signal source, meet professional needs
- ◆ T-bar simply switch signal source or transition effects
- ◆ USB 3.0 fast to live streaming
- ◆ Embedded & Insert Audio with Sync
- ◆ Mix audio from multiple inputs
- ◆ Chrome key, creating an exciting studio
- ◆ Configurable PIP video overlay
- ◆ PC/Phone remote control via APP (Feelworld Live Plus)

1.3 Front Panel Instruction

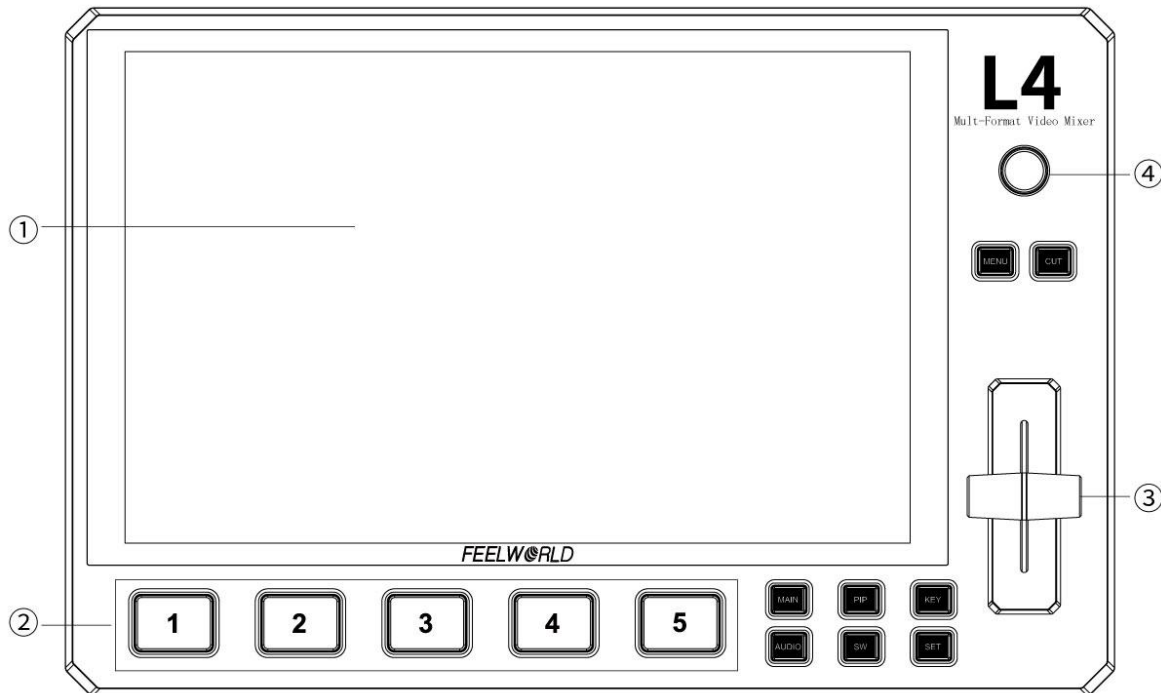



①	10.1-inch touch screen Display input sources + PST+PGM, MENU operation interface
②	Signal buttons 1~5 The lights on the signal source buttons will appear in three states Static Green: is on air (PGM), Flashing green: ready to be switched, No light: no input source or the source not supported by L4
MAIN	Main picture,click the input source can be switch signal
PIP	Picture in Picture Press to call out PIP operation interface
KEY	Chroma Key Press to call out Chroma Key operation interface
AUDIO	Press to call out Audio operation interface
SW	Press to call out Effect Switching, Signal cut method, Cut Duration,etc.menu interface
SET	Press to call out HDMI Output, PGM Format, Logo overlay menu interface.
③	T-bar Manual switching, push to top end or bottom end to switch signal to PGM (Note: when t-bar not on top or bottom end, the signal cannot be switched)

MENU	Menu back key
CUT	Press it to switch the signal from PST to PGM directly
④	Knob Rotate left or right to select menu items or adjust parameters. Press to confirm menu selection (icon turns red after confirmed)

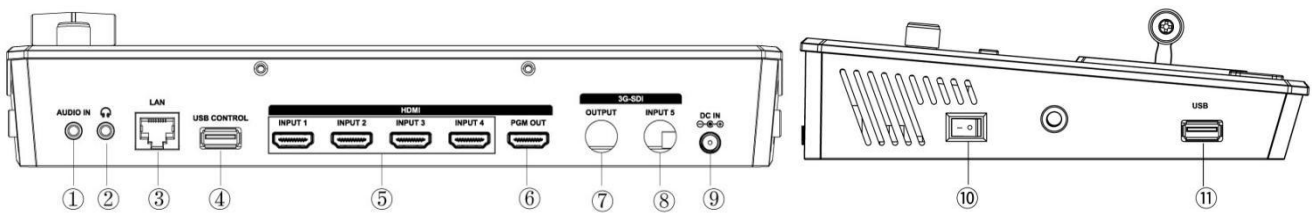
1.4 Interface Panel Instruction





No.	Interface	Instruction
①	AUDIO IN	Analog audio input port, connect to microphone
②		3.5mm Headphone jack
③	LAN	Communication port to link dedicated software for control
④	USB CONTROL	USB3.0 output, capture signal via third party streaming software and push to live broadcasting websites
⑤	HDMI 1~4 INPUT	4 HDMI inputs, connect to input source from HD camera or PC
⑥	PGM OUT	1 HDMI Output, it can connect to external display. You can select to show program picture (PGM) or multiple view (PST)
⑦	3G-SDI OUTPUT	3G-SDI signal output
⑧	INPUT 5	3G-SDI signal input
⑨	DC IN	1 DC Jack for power input, connect to 12V/3A power adapter.
⑩		Power Switch
⑪	USB	Firmware update/logo overlay import

Chapter 2 Install Your Product

2.1 Plug in Power

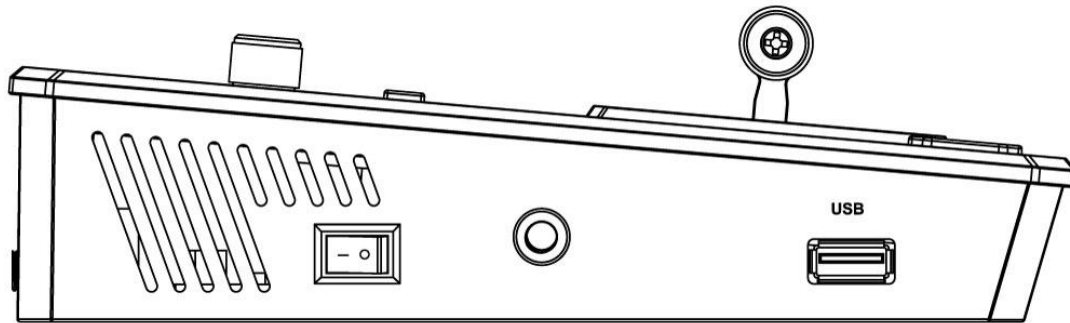
L4 is packaged with a 12V/3A power adapter, please check the power supply standard used in your country/region.



Turn on  after linking to the power

2.2 Connect Signal Source Input

You can use any camera, computer or other HDMI device as the input source of the L4. It supports up to 4Kp30 standard and 4 sources of different formats and resolutions at the same time. L4 also comes with SDI input, you can connect with SDI device.

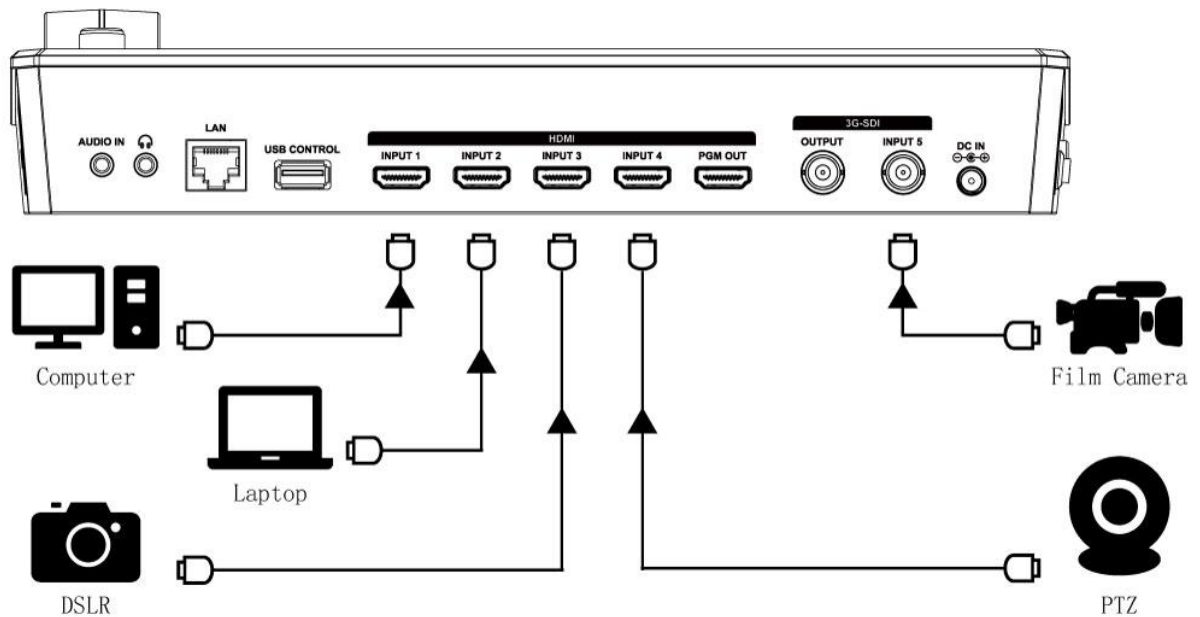

2.3 Connect HDMI and SDI Output

You can use a HDMI cable to connect the HDMI output to a monitor with an HDMI input interface, so that you can monitor the input, output and audio display in real time.

You can select PST or PGM mode for HDMI output

For PST mode, you can see the audio and video conditions of all input signal sources, you can see the current status of each function of L4, and you can also see the PST (Preset) and current PGM (program)output.

For PGM mode, HDMI output also supports single screen display of any one of the five inputs. You can switch between PST and PGM In menu.

HDMI output supports resolution setting . Click --PGM out, tap to select the output resolution format. HDMI output supports resolution up to 1080p60.

In addition, L4 also with a SDI output, you can connect to SDI monitor.

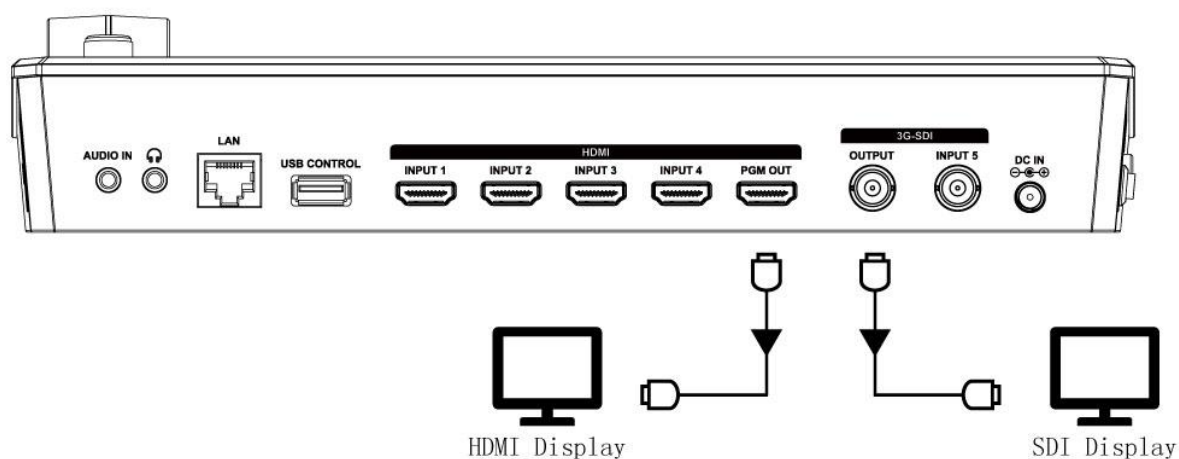

2.4 Connecting Microphone and External Monitoring Devices

L4 provides a 3.5mm audio input, you can connect microphone, also can use an external sound console to mix multiple external sound inputs.

L4 also provides a standard 3.5mm audio output, so you can use external speakers or headphones to monitor the L4's main output audio signal in real time.

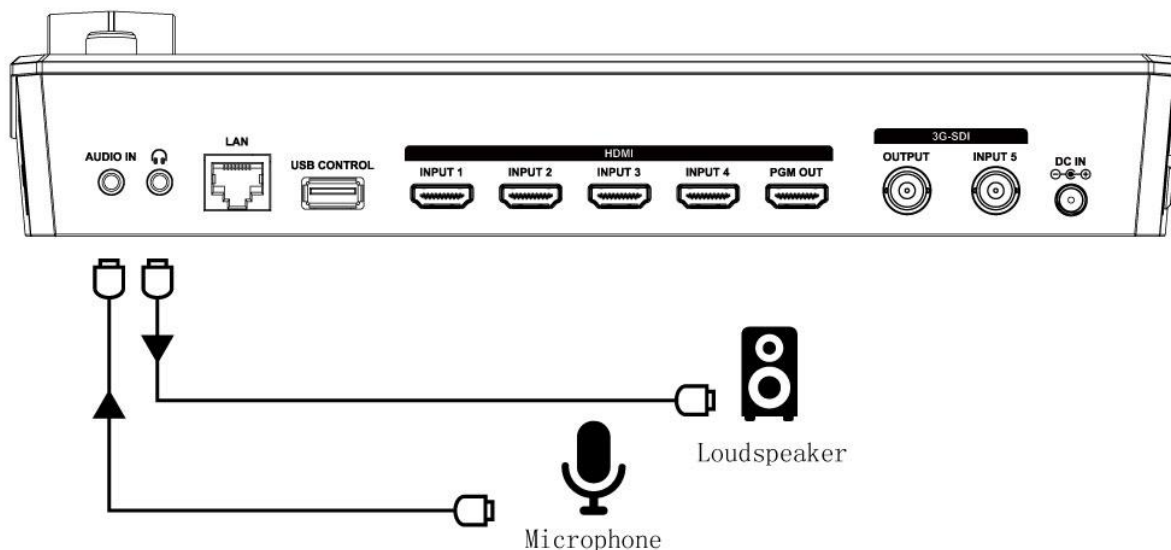

2.5 Connect USB3.0 as a Network Signal Source

You can use the L4's USB CONTROL port to use the L4 as a webcam source, and you can recognize the webcam signal from the L4 on live streaming platforms like Zoom, YouTube, Facebook, Twitch, OBS, etc.

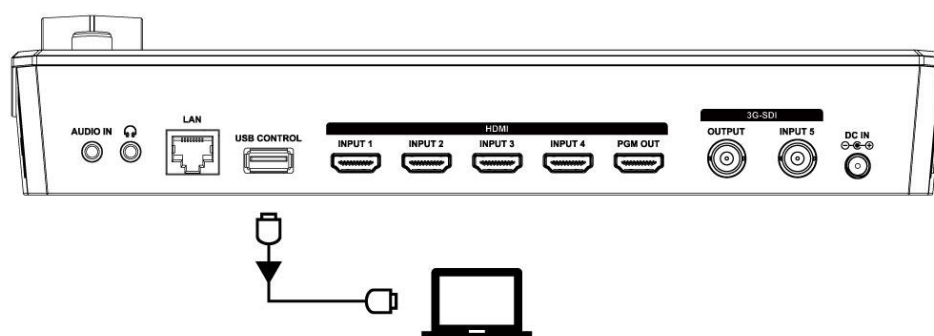

Note: If your computer only has a Type-C port, you can use a USB-A to Type-C cable to transmit the webcam signal. Please note that the Type-C cable you choose needs to support data transmission. The signal is recognized in Windows and MAC system as 「FEELWORLD USB 3.0 Capture」.

2.6 Connect Computer and L4

Software control: connect computer and L4 with CAT6 cable

Stream: connect L4's USB CONTROL and L4's USB 3.0 port with USB3.0 cable

(Note: the color of USB3.0 port is blue)

Minimum System Requirements for macOS (Note: the following system is an example, it doesn't mean only this system supported)

- macOS 11.0 Big Sur or later

- macOS 10.15 Catalina

Minimum System Requirements for Windows

- Microsoft Windows 10 64-bit

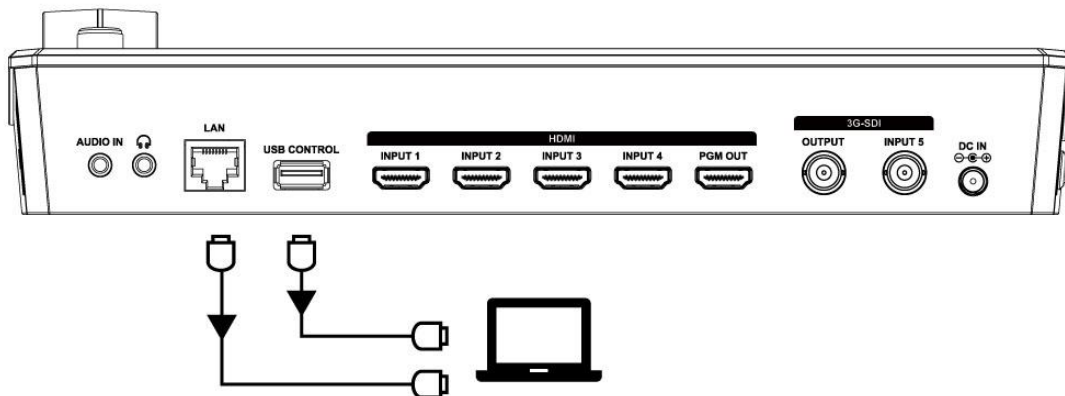

Note: The IP address of the L4 must be in the same WLAN segment as the computer.

2.7 Connect USB2.0 for Firmware Update

When L4 need to upgrade, you can update via the USB2.0 port.

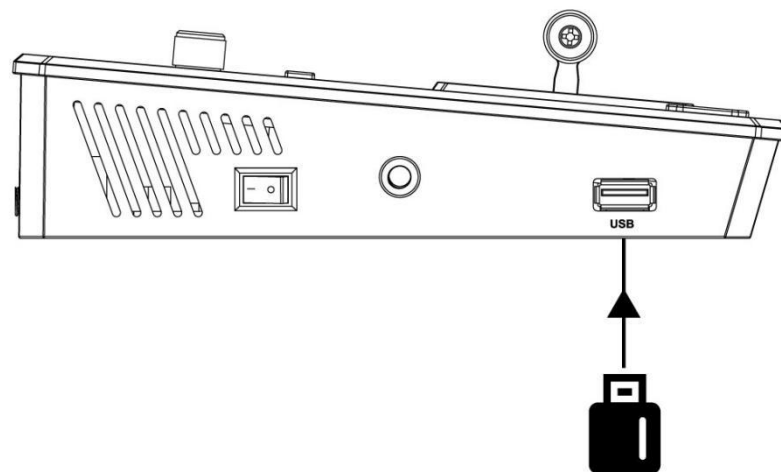

Steps for firmware update:

1. Format USB flash driver as FAT32
2. Copy the firmware update file to USB flash driver, insert to USB2.0 port of L4 (the color of USB2.0 port is white). Then turn on power of L4 (if L4 turned on already, please turn off first and turn on again), the buttons on the panel will be flashing after turned on power.
3. The buttons stop flashing after finish update, please reboot the L4.

Chapter 3 Use Your Product

3.1 Touch Screen

On the front panel of L4, you can see a 10.1-inch touch screen as shown in the picture below:

The LCD screen presents 5 input sources, PST preset picture, PGM output picture and the menu operation interface.

You can easily tap the picture of signal source directly to switch input source. All of control can be finished by touching.

You can click on any position of PGM window, and the current set information (Mode, Input, Main Audio, Mix Audio, Brightness, Contrast, R.G.B value) can be displayed in the upper right corner of PGM and PST. Click again to exit.



3.2 Button Instruction

Except touch control, L4 also with physical buttons. You can press directly to call out the corresponding menu quickly, such as press button **PIP** can be call out PIP menu immediately. Then rotate the knob to select the needed function or value, press the knob after selected to confirm.

3.3 Menu Operation Instruction



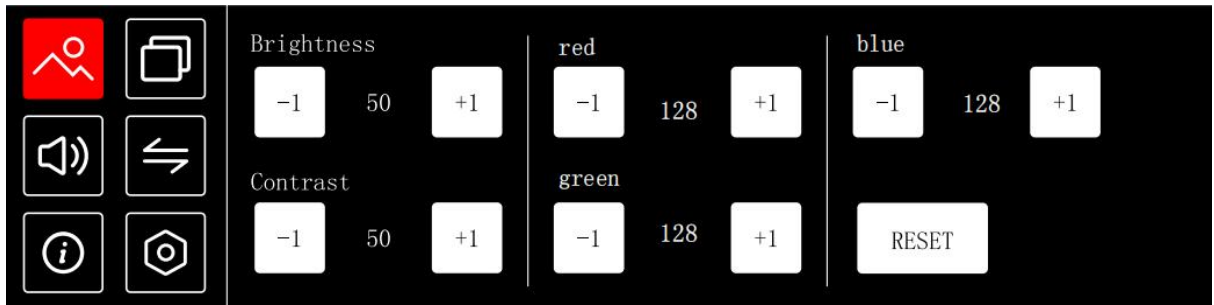

Click to adjust parameter values to adjust the brightness, contrast, and R.G.B color values of the image

is increase value, is decrease value

Brightness: 0~100

Contrast: 0~100

R.G.B: 0~255

RESET: After click RESET, the value reset to default value R.G.B 128, Brightness/Contrast 50



Including MAIN, PIP, KEY

MAIN

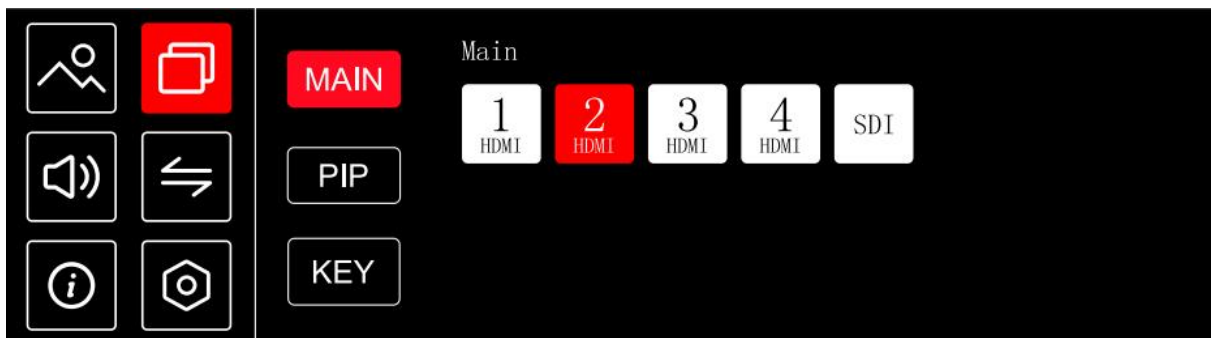

Click MAIN of menu interface or press button MAIN to enter main picture menu, you can click any one input sources switch to PST (Preset)

PIP

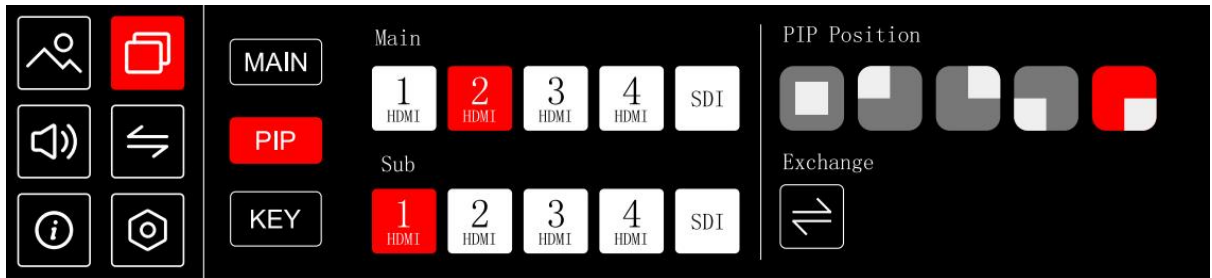

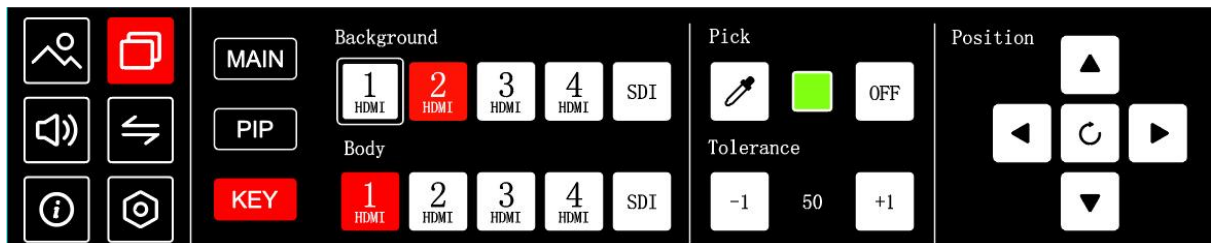

Click **PIP** of menu interface or press button **PIP** to enter Picture in Picture menu. Select the signal source of main and sub picture, then you can see the selected signal in the PST (preset) interface. You can choose the position of the PIP , and also can click **Exchange** to quickly exchange the main picture and sub picture.

KEY



Click **KEY** of menu interface or press button **KEY** to enter chroma key menu

Steps of chroma key:

1. Click to select the signal source for Background and Body
2. Click on the icon  to pick the color, the color selection can be pick by clicking on any position of Body signal source or by clicking up, down, left, and right to adjust the color selection position
3. After selecting the color, click on the chroma key switch  OFF
4. Click the tolerance value to adjust the chroma key effect

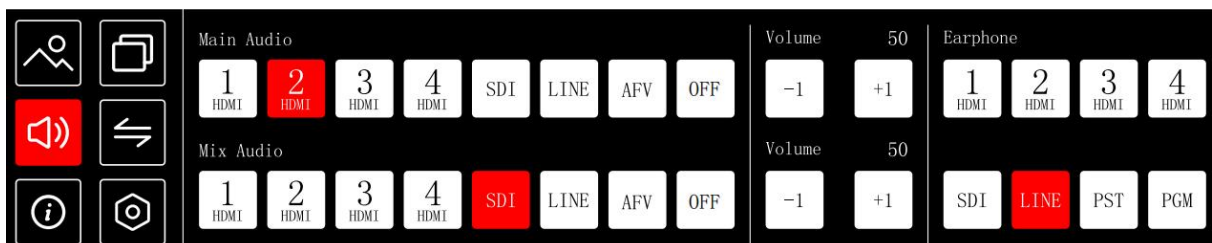



Click icon  or press button **AUDIO** enter audio menu

Mixing: You can choose one channel from Main Audio and one channel from Mix Audio for mixing

Volume: Adjust the volume of main audio and mix audio 0~100

Earphone: you can select any channel you want to monitoring

When AUDIO IN is connected to a microphone, click to select  so that you can better hear the sound; When L4 is connected to electronic devices such as computer, smart phone, etc, you can plug headphone into the AUDIO IN port of L4 and click select  to listen to audio from electronic device.

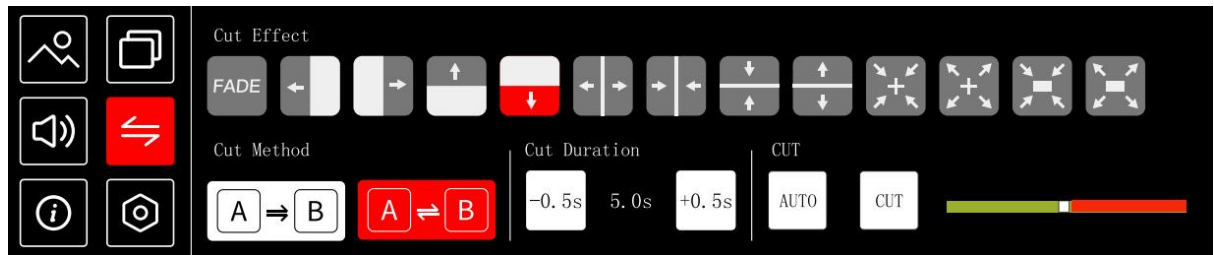

Click icon  or press button **SW** to enter transition effect menu

Cut Effect: Click to select the transition effect, there are 13

Cut Method: A=PST, B=PGM

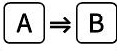
: Indicates PST is directly switched to PGM, and after switching, the PST and PGM screen are the same.

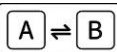
: Indicates that the PST picture switches to PGM, and the PGM picture returns to PST.

Cut Duration: 0.5S~5S

CUT: AUTO, CUT

When select AUTO, you can set the switching time 0.5~5S. eg. You set the time 4S, the screen will finish switching within 4 seconds.

When select CUT, the screen switch directly.



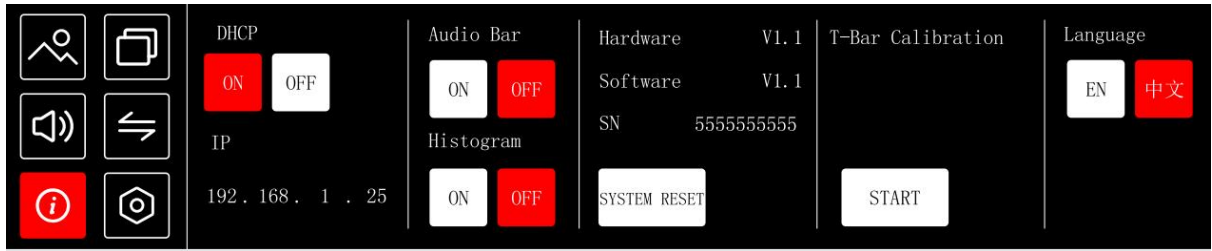

The device supports set IP address Manually and Automatically

SET IP Address Manually

Turn **OFF** DHCP and select **each segment** with the knob, then press to enter and set the **value** of each segment by pressing the knob again.

Set IP Address Automatically

Use this setting if your network/router has a DHCP serve

Turn **ON DHCP**

manual setting is disabled, and the IP Address for L4 is set from the network.

Audio Bar: On/Off

Histogram: On/Off after turning on , the histogram will be shown on the lower right corner of PST and PGM

Version Info.: including hardware version, software version and SN

T-bar Calibration: Click **START** and follow the prompts to calibrate T-bar

Language: EN, 中文

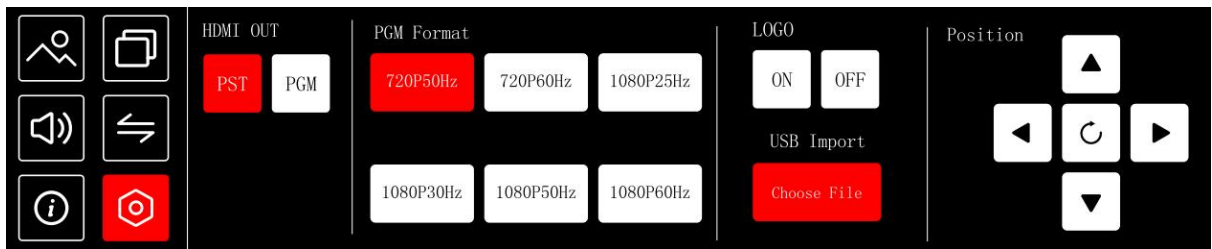

HDMI OUT: PST, PGM

PST: It is for multi-view

PGM: It is for main picture output

PGM Format: click to select resolution of program out

LOGO: ON/OFF

Export the LOGO file from the software FEELWORLD Live Plus (details see 5.2.2 SW - LOGO Overlay - Export Bin) to the USB flash drive, then insert it into the USB2.0 interface of L4.

Click to **Choose File** to import the LOGO , and then click "ON" to open LOGO overlay function.

Position: adjust the logo position using the up, down, left, and right arrow keys

Note: only support import one LOGO a time

3.4 Switch Source

When you access the five source buttons, the lights on the source buttons will appear in three states:

green constant: the signal is currently on the main output;

green flashing: the currently selected, signal is being edited;

unlit: the source is not accessed or the resolution of the accessed source is not supported by the L4

After transition effect and transition mode is selected

In AUTO+Time Mode:

1. Press a source button (1, 2, 3, 4 or 5) ,the selected button is green flashing.
2. Selected source will be switched to the output with the set TIME and using the transition selected, the pressed source button becoming green constant .

Slide the T-BAR to switch

1. Press a source button (1, 2, 3, 4 or 5) the selected button is green flashing.
2. Slide T-Bar from top end to bottom end or reversely, then the pressed source button becoming green constant.

Chapter 4 Streaming

4.1 OBS Streaming

Video Capture

L4 is compatible with many third party steaming software, we recommend OBS, which is available to download on <https://obsproject.com/download>. Download the software and update to the latest version.

1. Click "+" icon

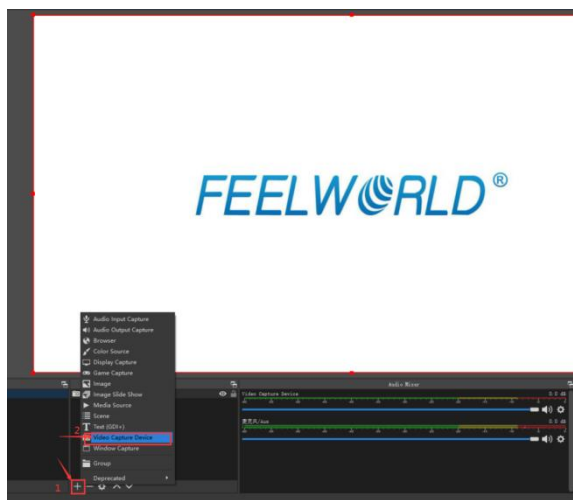

2. choose video capture device

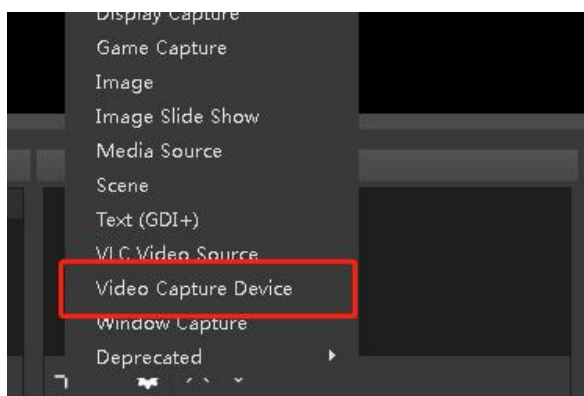

3. Choose : FEELWORLD USB 3.0 Capture and Choose Video Format YUY2



Note: If there is no video format YUY 2 after setting above, check the USB 3.0 port connection. Make sure it is linked to USB 3.0 port on PC by USB 3.0 cable. (USB 3.0 cable or port is standard in blue while USB 2.0 is in black). If the captured , change the video format to YUY2.

Audio Setting

When there is no audio playing first check the video source see if the it is set in default value and then check the audio setting on OBS.

1. Set Default for the audio source.
2. Audio setting on OBS.

Choose Audio, click Setting and choose audio device (Mic/Auxiliary Audio Device)

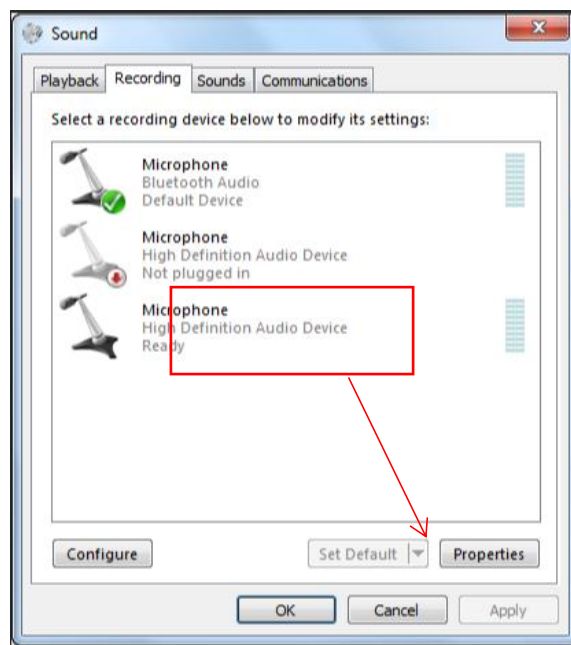

Synchronize Video with External Audio

When the video itself doesn't have embedded audio and need insert external audio. Here are the steps.



1. Set the audio source: Setting→Audio→Mic/Auxiliary Audio Devices

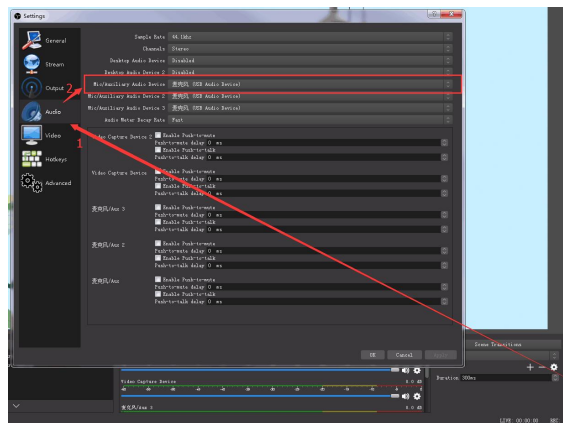

2. Right click the Video Capture Device in Source and choose Filter

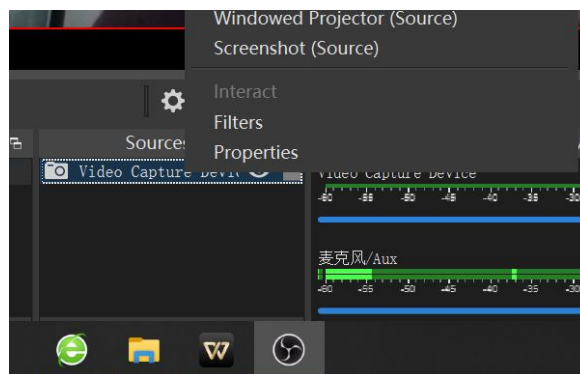

3. Click "+" under Audio/Video Filters and choose Video Delay (Async)

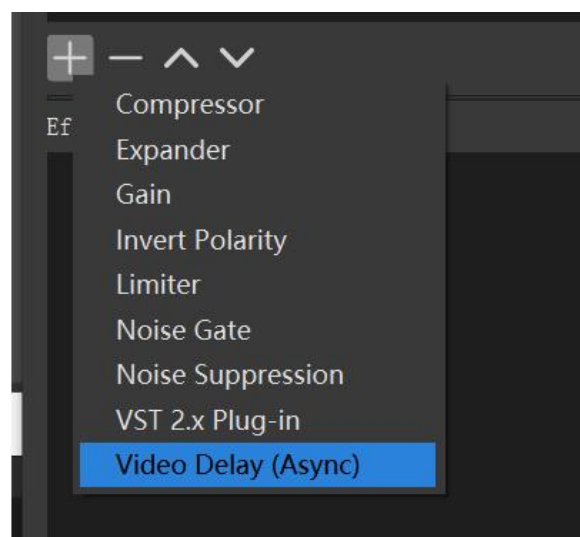

4. You can custom the filter name in the pop-up window. Click OK to confirm the filter name.

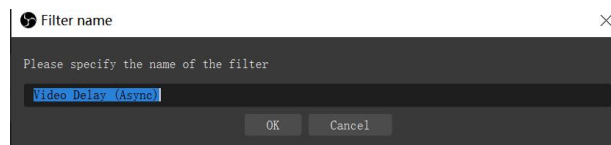

5. Input delay value in ms, the value need to adjusted until the video and audio is synchronous.



Streaming Setting

1. Find the RTMP URL and Stream Key provided by streaming broadcast website.
2. Copy URL and Stream Key
3. Back to OBS, click Setting in the lower right corner and click "Stream". Choose Stream Type as "Streaming Service" or "Custom Streaming Server" . If choose "Streaming Service", there is a list of streaming service name available in the drop down list of Service. If the streaming service is in the list, choose it from the list.
If choose Custom Service, just fill in URL and Stream Key.

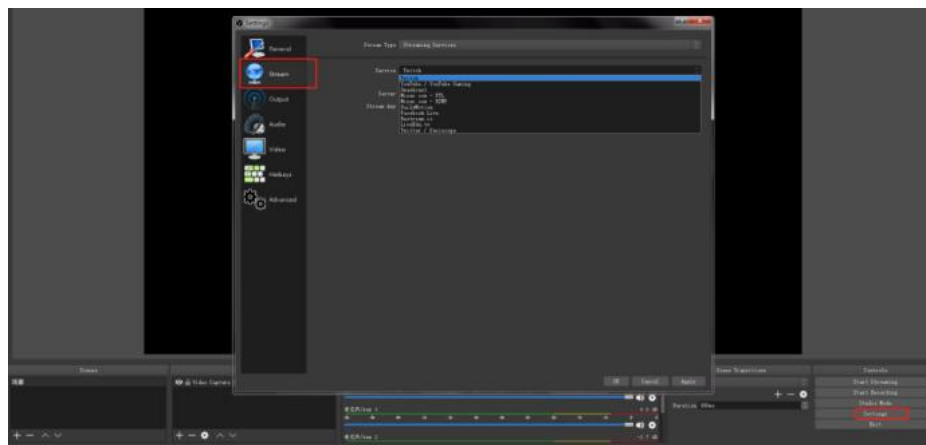

4. Paste the RTMP URL to Server or URL and Stream Key to Stream Key.
5. Click "Start Streaming".
6. Go back to live broadcast website and check the broadcasting.

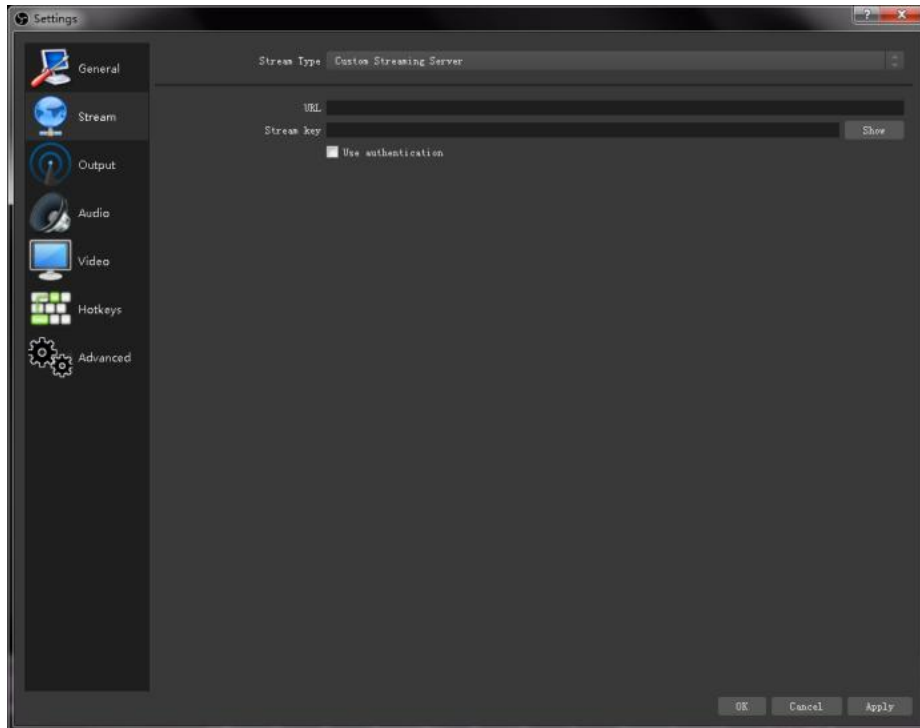

4.2 vMix Streaming

L4 streaming via vMix steps are as follow:

1. Click a new blank, then click the "Add Input"

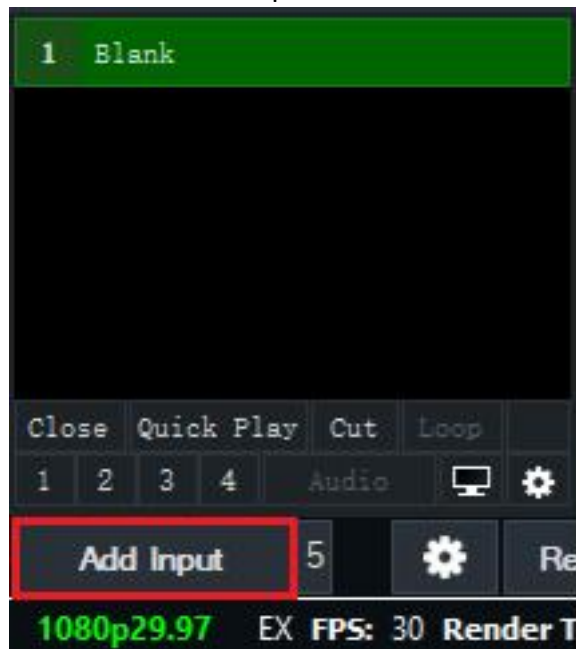

2. Select Camera-Camera-FEELWORLD USB3.0 Capture.

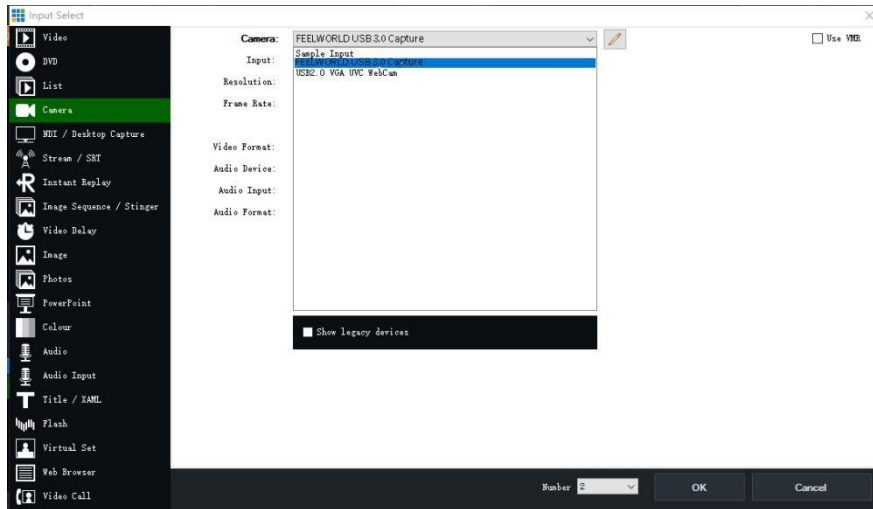

3. Select the same resolution as the L4 output. Then click “OK”.

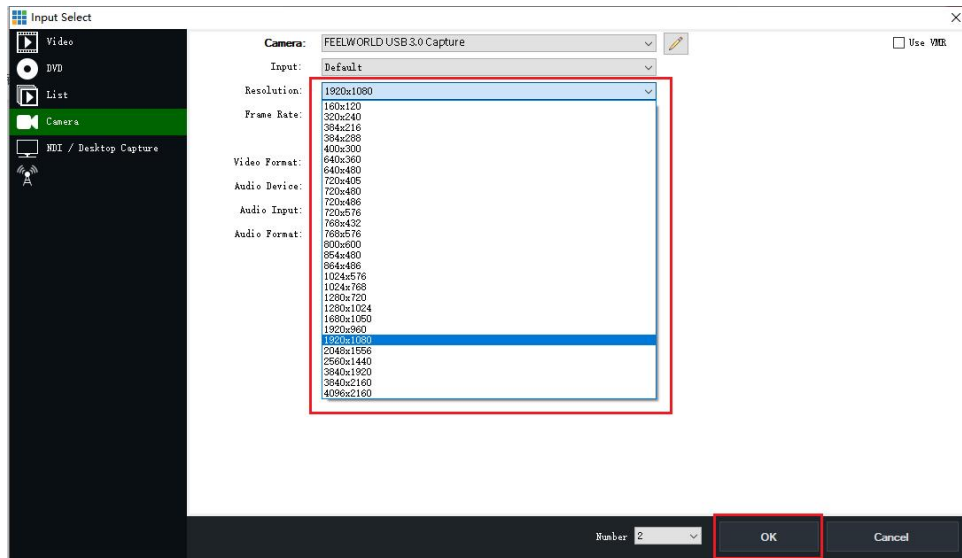

4. Click “Stream” setting button.

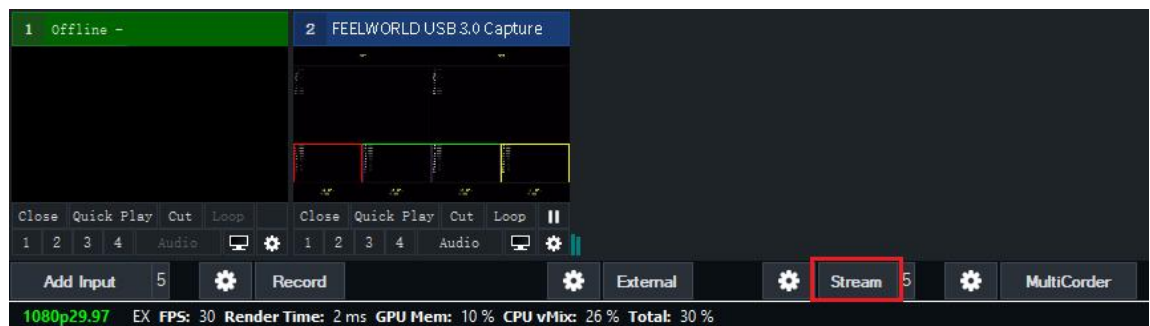

5. Complete the URL and Key information. Click “Start 1”, vMix will begin streaming.

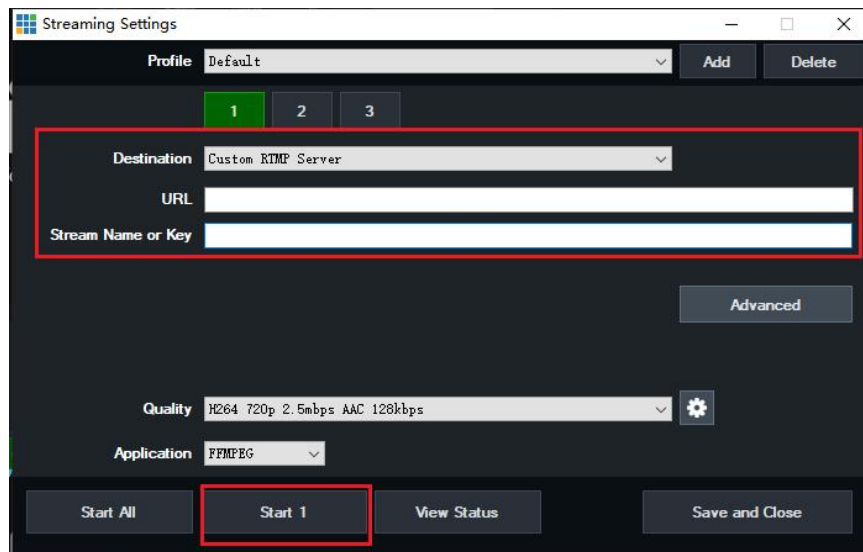

Note: vMix does not support automatic recognition of the output resolution of L4. Every time the output resolution of L4 is modified, the picture on vMix will pause. The user needs to re-select FEELWORLD USB3.0 Capture and manually input the current output resolution of L4.

Chapter 5 Feelworld Live Plus Software Operation

Feelworld Live Plus is a software that allows you to control your L4, FEELWORLD is available for all platforms including Android, iOS, MacOS, Windows.

Minimum System Requirements for macOS

Windows:

- CPU: i5 and above
- Memory: 8 GB or more
- Operating System: Windows 10 64 bit processor or above
- Graphics: Support Direct X9 128M or above (open AERO effect)
- Hard disk space: Above 16G (primary partitions, NTFS format)
- Connector: USB 3.0 or type-c
- Others: do not run multiple video capture or editing software simultaneously

MAC:

- CPU: i5 and above
- Connector: USB 3.0 or type c
- Operating System: macOS 11.0 Big Sur or later
macOS 10.15 Catalina
- Others: do not run multiple video capture or editing software simultaneously

You can either connect the L4 directly to your computer via the LAN port provided by the L4, or link the L4 to your router and the computer to the Wi-Fi emitted by your wireless router.

Note: The IP address of the L4 must be in the same WLAN segment as the computer or the mobile control device you choose.

5.1 Connect L4 and computer

5.1.1 Direct Link via a Network Cable

(1) Modify L4's IP Address

The L4 is connected to a computer via TCP/IP protocol for data transfer. Therefore, you need to keep the L4 on the same IP network segment as your PC or mobile device. If the L4 is connected directly to a computer, you need to change the L4's IP manually to avoid IP conflicts on the same network segment.

Steps to modify L4's IP address:

- ①. click icon  --IP address
- ②. click the value which need to modify and rotate the knob to modify or swipe left and right to modify.

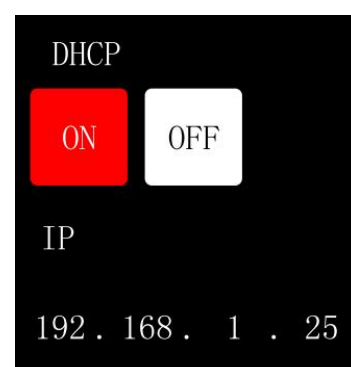

③. Press knob to confirm after modified the value

(2) Change the PC's IP Address

To ensure that the L4 and the PC can communicate smoothly, the IP address of the computer needs to be verified.

Steps to modify the IP address of the Ethernet port (windows).

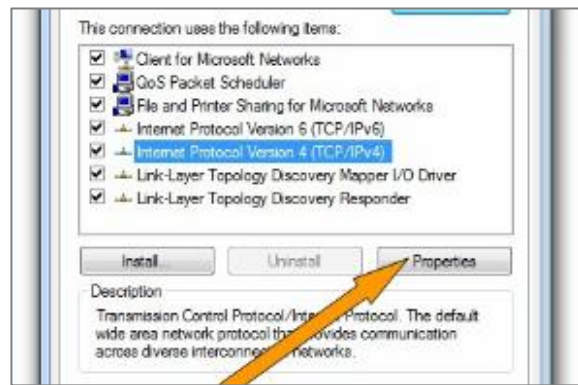
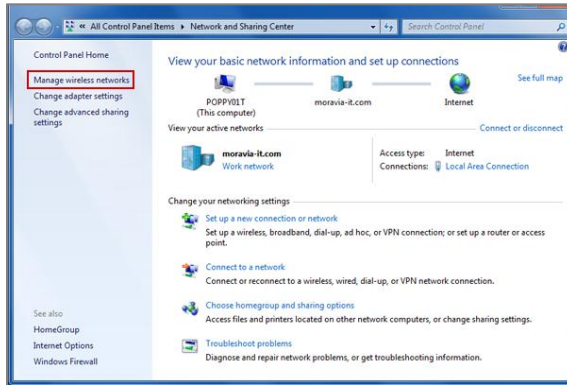

1. Open the Network Sharing Center;
Click on "Ethernet";

2. Access to Properties may require administrator privileges;
Under "This connection uses the following items",
find "Internet Protocol version 4 (TCP/IPv4)";

IP Address	192 . 168 . 0 . 101
Subnet Mask	255 . 255 . 255 . 0
Default Gateway	192 . 168 . 0 . 1

3. Select "Use the following IP address" and change the IP address to the same network segment as L4 eg: L4's IP address is 192.168.0.99, then the computer's IP address can be set to 192.168.0.1-255. Please make sure that the IP addresses do not conflict.

Connect Wirelessly with Your Router

The L4 provides wireless control, so you can control it from a greater distance when the L4 is not in your immediate vicinity. A wireless router is required to use this feature. The computer receives the WIFI signal from the wireless router you connect the L4 to.

Steps of wireless connection:

- ①. Connect the L4 to the router's LAN port
- ②. Click icon , turn on DHCP switch
- ③. Computer connects to Wi-Fi from the router

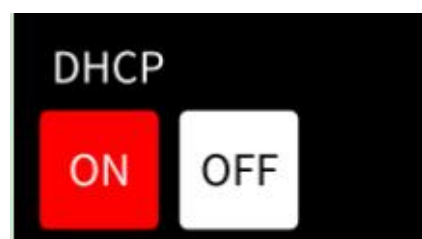

④. Open Feelworld Live Plus and search the device

Note:The Android and IOS versions can only connect wirelessly. Regardless of whether you are using wireless or wired, you need to make sure that the IP addresses are on the same network segment and that they do not

5.2 Using Feelworld Live Plus (take MAC version as example)

Feelworld Live Plus simulates the L4's real world appearance and the operations you can control with Feelworld Live Plus are very similar to those you can do with the L4's hardware.



After software is installed, click the icon  login the software, you can add device by handle or search device automatically.

Add device by handle

Keying the IP address same as L4, then click **Sure** to add



Search device automatically

1. Click icon  on L4, then turn on DHCP switch
2. Click icon  to search device, after searching, the available L4 device in the sub-net can be found.



Select the desired device by SN and IP and enter the management window, if the connection is successful, the indicator light in the lower left corner displays green, and if the connection is fail, the indicator light is red.



5.2.1 MENU

Click **【MENU】** can set HDMI, Streaming Media, Audio, etc.

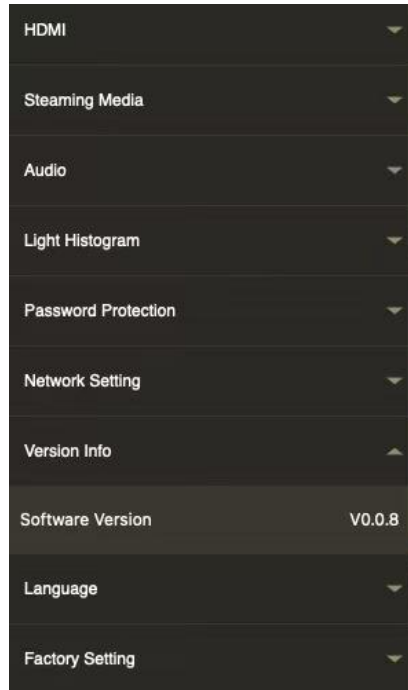

HDMI

Out picture: including PST and PGM

Resolution: 720p@60, 1080p@25, 1080p@30, 1080p@50, 1080p@60 for optional
Click <Setting> after selected

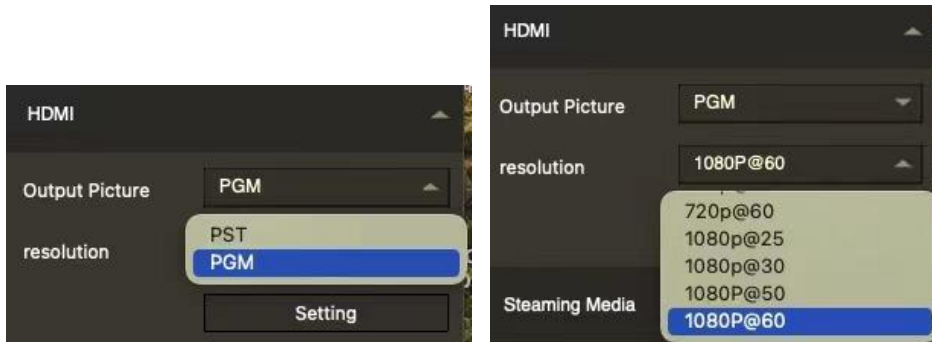

Streaming Media

Capture Device: Choose FEELWORLD USB3.0 Capture

H.265: Turn ON/OFF , when turn it on, users can watch the output picture on software

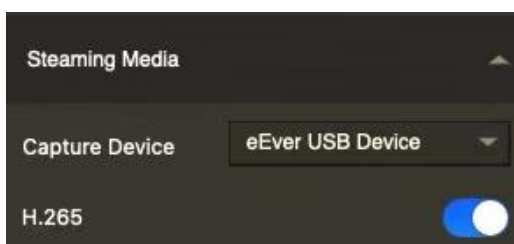

Audio

Audio Bar: Turn ON /OFF the audio level

Audio Monitor: Click to choose the monitoring channel



Light Histogram

Histogram Open: Turn ON/OFF histogram. When turn it on, the histogram will show on lower right corner of PST and PGM

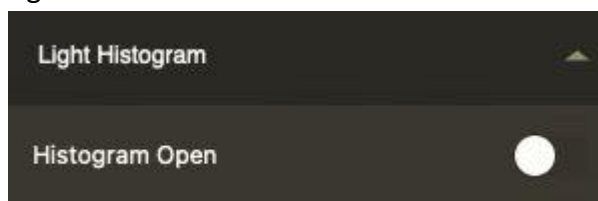

Password Protection

In order to solve the problem of control conflicts caused by different devices controlling the same L4 in the same LAN, Feelworld Live Plus provides a password protection function, as an administrator, you can set a password for the device controlling Feelworld Live Plus, and when you control the interface again, you need to enter the password to control it.

Note: If you have forgotten your password, please restore the factory settings on the L4



Network Setting

In **【Network Setting】** , you can check current IP, mask and gateway.

If you want to change the IP address,mask and gateway, turn **off DHCP** first and change the value, then click Setting.

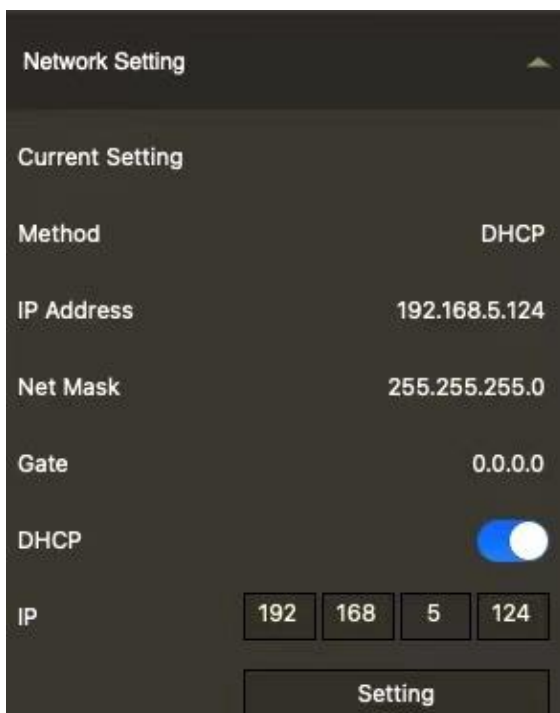

Version Info

Click **【Version Info】** to check the software version

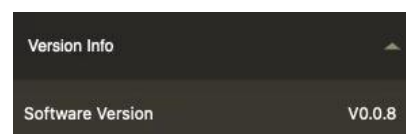

Language

There are Chinese, English for option



Factory Setting

Click **【Factory Setting】** will remove all settings.

5.2.2 SW

Click **【SW】** including Chroma Key and LOGO overlay

Chroma Key

Click KEY of **【MODE】** , choose the signal source of Background and Body

Click  to pick color, then click KEY button

Click **【SW】** can adjust the Tolerance



LOGO Overlay

Click **Choose Picture** to choose LOGO image from your computer (size of image should be within 256x128 pixels)

Click **Import** to upload the LOGO

Click the function open button after import 100%

Location: You can adjust the LOGO position

Export bin: Click it to export the LOGO to USB flash driver, then you can insert the USB flash driver to the USB2.0 port of L4 and import the LOGO to L4.

Note: only can import one logo picture, when import new one ,the original one will be covered.

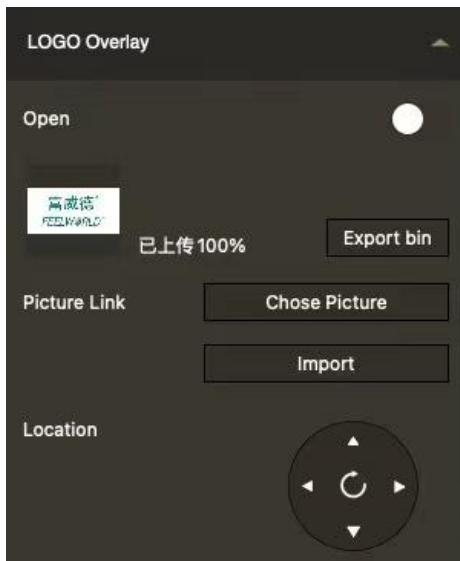

5.2.3 Mode

MAIN

Click **【MAIN】** to select signal source for main picture, red is the signal for PGM, green is the signal for PST



PIP

Click **【PIP】** can set for picture in picture
 Click to choose the signal of main picture and sub picture

Click icon  can choose the PIP mode

Click icon  can exchange main picture and sub picture



KEY

Click **【KEY】** , the operation same as Chroma Key of 5.2.2 SW

5.2.4 Switching

CUT: click to switch the signal PST to PGM directly

AUTO: under AUTO mode, can set Cut Duration for effect or signal source (max 5 seconds)

Note: T-BAR is for manual switching

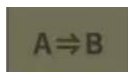

: Indicates PST is directly switched to PGM, and after switching, the PST and PGM screen are the same.

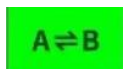

: Indicates that the PST picture switches to PGM, and the PGM picture returns to PST



5.2.5 Audio

You can choose one channel from Main Audio and one channel from Mix Audio for mixing, and can adjust the volume

Main Audio **Main Audio Volumn**

HDMI 1 HDMI 2 HDMI 3 HDMI 4 SDI LINE **AFV** OFF

Mix Audio **Mix Audio Volumn**

HDMI 1 HDMI 2 HDMI 3 HDMI 4 SDI LINE AFV **OFF**

Chapter 6 Product Parameters

Screen	10.1-inch (touch)		
Connections	Input	HDMI In	4×HMDI
		SDI In	1x 3G-SDI
	Out	HDMI Out	1xHDMI
		SDI Out	1x 3G-SDI
		USB3.0	1×USB TypeA
	Audio	IN	1×3.5mm (MIC)
		OUT	1×3.5mm (LINE)
	Communication	LAN	1×RJ45
Power		1×DC Jack	
Performance	Input Resolutions	HDMI SMPTE 720p@50/60 1080i@50/60 1080p@24/30/50/60 2160p@30 VESA 1024X768@60 1280 X 720@60 1280 X 768@60 1280X800@60 1280X1024@60 1360x768@60 1366x768@60 1440x900@60 1600x1200@60 1680x1050@60 1920 X1080@60 1920x1200@60 3840x2160@23.97/24/25/30	
		SDI 720p (60/59.94/50/30/29.97/25) 1080i(60/59.94/50) 1080p (60/59.94/50/30/29.97/25/24/23.98)	
	Output Resolutions	HDMI SMPTE 720p@50/60 1080p@25/30/50/60 VESA 1024x768@60 1280x720@50/60 1280x768@60 1280x1024@60 1360x768@60 1920x1080@25/30/50/60	
		SDI 720p (60/59.94/50/30/29.97/25) 1080i(60/59.94/50) 1080p (60/59.94/50/30/29.97/25/24/23.98)	
		USB 720p50/60 1080p25/30/50/60	
Supported Standards	HDMI	1.4	
	USB	3.0	
Power	Input Voltage	DC 12V/3A	
	Max Power	≤ 27W	
Environment	Temperature	0℃~60℃	

	Humidity	10%~85%
Physical	Weight	1.48kg
	Dimension	290.2(L) x 189.5(W) x 55.7(H)mm