



SHINOBI SDI

User Manual

EDITION 1: APRIL 2019



Register your SHINOBI SDI to receive the latest software updates and user information

Registering your product ensures you receive communication on all future updates

Contents

Warranty & Conditions

Introduction

1. What's included

2. What you also need

SDI Cables

HDMI Cables

Standard 1/4" Mount

3. Powering the Shinobi SDI

Power ON/Power OFF

4. Shinobi SDI connections

5. Using the Shinobi SDI

Best Practice

- Screen Lock

- Firmware updates

Setting up for monitoring

Main Screen - Information Bar

Home Screen / Menu functions

- Video input

- Audio

- Battery

- Info

Monitor Features

Using Waveform Monitoring Tools

RGB Parade / RGB Overlay / Vectorscope

Histogram / RGB Histogram / Analysis

Using Monitor Assist Tools

Focus Peaking / Zebra / False Color

Blue Only / Zoom / Grid Lines / Safe Guides / Desqueeze

LUTs

Monitor

- Using Standards – Native / Rec709 / HLG / PQ

- Understanding HDR and Log

Display

6. Technical Specifications

Safety Instructions

1 The Shinobi SDI is designed to a high standard but there are some things
2 you should be aware of to prolong the life of the unit and for your own
3 safety.

3

Using the Shinobi SDI safely

3 Although the Shinobi SDI is very lightweight compared to all the devices it
3 replaces, it is still a solid object that could cause injury if misused.

4

5 • Always make sure that the Shinobi SDI is mounted securely and is unable
6 to fall onto anyone nearby. This is especially important when there are
7 children present who might be tempted to pull on cables.

7 • Always ensure that cables that run to the Shinobi SDI are clearly visible
7 and do not present a trip hazard.

7 • Do not place on uneven or unstable surfaces.

9 • Do not touch the Shinobi SDI screen with sharp, metallic or abrasive
10 objects.

10 • Do not expose to strong electrical or magnetic fields.

11 • Do not expose to liquids, rain or moisture.

12 • Do not dispose of the Shinobi SDI in municipal waste and do not incinerate
12 it, always follow local regulations for safe disposal.

12

13

SDI cables

14 Please remember that SDI cables use locking connectors and will not
14 simply pull out if they are jerked or tripped over. They are therefore a
15 significant trip hazard to your equipment, which may be damaged if the
16 cables are misused.

16

17

HDMI cable

18 Please remember that almost all HDMI cables do not use locking
19 connectors and will simply pull out if they are jerked or tripped over.

19 Please ensure your cables make a secure connection and avoid flexing
20 them excessively to maintain reliability.

21

22

User Manual Conventions

To keep things simple but clear, we've only adopted two conventions
in this manual:



*A helpful tip, suggestion or something to note
because it's not obvious at first.*



An important note or warning

Warranty & Conditions

International Hardware Limited Warranty

ATOMOS warrants that:

- The main product, not including the IPS screen, or any external accessories, will be free from defects in materials and workmanship for a period of 1 year from the date of purchase.
- The TFT/LCD, HDD/SSD Docking Station, Master Caddy II and Cable will be free from defects in materials and workmanship for a period of 1 year from the date of purchase.

This warranty is exclusively for the benefit of the original purchaser and is not assignable or transferable.

If during the warranty period the product is shown to be defective ATOMOS may at its option:

- a) replace the goods or supply equivalent ones,
- b) repair the goods,
- c) pay the cost of replacing the goods or of acquiring equivalent ones and
- d) paying the cost of having the goods repaired;

The customer must notify ATOMOS of any defect in the goods in writing prior to the expiry of the warranty periods set out above. The customer will be solely responsible for returning the goods to ATOMOS or its authorized distributor. Upon acceptance of a warranty claim by ATOMOS, where ATOMOS repairs or replaces the goods, it will be responsible for reasonable shipping costs incurred in sending the goods to the Customer, provided that customer is located in a country in which ATOMOS has an authorized distributor or repair center or agent.

Warranty Exclusions

This warranty applies only to defects in workmanship and does not cover defects caused by:

- Neglect;
- Improper or negligent acts or omissions;
- Repairs or attempted repairs;
- Tampering with or modification of the goods;
- Connection to incompatible equipment or power sources;
- Exposure to water or weather;
- Exposure to magnetic fields or corrosive liquids or substances;
- Physical damage

Except as stated in this warranty, Atomos, its vendors, agents, resellers and distributors disclaim in their entirety all other warranties, express or implied, including without limitation all warranties of merchantability or fitness for a particular purpose. The remedies outlined in this warranty are the exclusive remedy a customer from defective goods, which are subject to the warranty.

Atomos does not warrant that the goods will operate in a manner that is error free, or uninterrupted.

Software License Agreement

IMPORTANT, PLEASE READ CAREFULLY. THIS IS A LICENSE AGREEMENT.

This ATOMOS software, related documentation, any included sample images files (the "Software"), is protected by copyright laws and international copyright treaties, as well as other intellectual property laws and treaties. The Software is licensed, not sold.

This End User License Agreement ("EULA") is a legal agreement between you (either an individual or a single entity) and ATOMOS with regard to the copyrighted Software provided with this EULA. Use of the Software provided to you by ATOMOS in whatever form or media, will constitute your acceptance of these terms, unless separate terms are provided by the software supplier, in which case certain additional or different terms may apply. If you do not agree with the terms of this EULA, do not download, install copy or use the Software. By installing, copying or otherwise using the Software, you agree to be bound to the terms of this

EULA. If you do not agree to the terms of this EULA, ATOMOS is unwilling to license the Software to you.

- 1. Eligible licensees.** This Software is available for license solely to purchasers of the ATOMOS Shinobi SDI, who have purchased a unit manufactured by ATOMOS Shinobi SDI and purchased through an ATOMOS authorized reseller, with no right of duplication or further distribution, licensing or sub-licensing.
- 2. License Grant.** ATOMOS grants you a personal, non-transferable and non-exclusive right to use the copy of the Software provided with this EULA. You agree you will not copy the Software except as necessary to use it with the ATOMOS Shinobi SDI. You agree that you may not copy the written materials accompanying the Software. Modifying, reverse engineering, translating, renting, copying, transferring or assigning all or part of the Software or any rights granted hereunder, to any other persons or reverse engineering the hardware on which the Software runs, is strictly prohibited. The software is license, not sold. You acknowledge that no title to intellectual property in the Software is transferable to you. You further acknowledge that title and full ownership rights to the Software will remain the exclusive property of ATOMOS and/or its suppliers, and you will not acquire any rights to the Software, except as expressly set forth above. All copies of the software will contain the same proprietary notices as contained in or on the Software. All title and copyrights in and to the Software (including but not limited to any images, animations, video, audio, text incorporated), the accompanying printed materials, and any copies of the Software are owned by ATOMOS or its suppliers.
- 3. Reverse engineering.** You agree that you will not attempt, and if you are a corporation, you will use your best efforts to prevent your employees and contractors from attempting to reverse compile, derive circuits, modify, translate or disassemble the Software and/or the Atomos Shinobi SDI in whole or in part. Any failure to comply with the above or any other terms and conditions contained herein will result in the automatic termination of this license and the reversion of the rights granted hereunder by ATOMOS.

ATOMOS reserves the right to terminate this license without prejudice to any additional recourse ATOMOS may have against you if you violate any of its terms and conditions.

Notice

Copyright © 2019 ATOMOS Global Pty Ltd ('referred to as ATOMOS'). All rights reserved. All information in this document is subject to change without notice. No part of the document may be reproduced or transmitted in any form, or by any means, electronic or mechanical, including photocopying or recording, without the express written permission of ATOMOS. A reference to ATOMOS includes its related entities, subsidiaries and parent company.

Trademarks

Shinobi SDI and ATOMOS are registered trademarks of ATOMOS. Apple, the Apple logo, AppleShare, Mac, and Macintosh are registered trademarks of Apple Inc. Final Cut Pro, QuickTime and the QuickTime Logo are trademarks of Apple Inc. DNxHD, DNxHR and Avid logo are registered trademarks of Avid Technology, Inc. All other trademarks are the property of their respective holders.

REGISTRATION + WARRANTY

Visit: www.atomos.com/register

Registered users receive updates of all AtomOS updates upon release.

Introduction

SHINOBI SDI

Thank you for choosing the Atomos Shinobi SDI 5.2 inch HDR Monitor. Featuring a super high-resolution screen in a lightweight polycarbonate ABS chassis, and an array of essential production tools including waveform monitoring, vectorscope, luma, focus assist and the world's leading support for HDR monitoring.

This user manual will get you up to speed with all the amazing features packed into the Shinobi SDI. Stay up-to-date with the latest information and software by registering your product today

www.atomos.com/support



1. What's included

Your Shinobi SDI includes base accessories to get you started, such as a mains power supply. Additionally you will need a compatible SDI cable (1.5/3G) [Camera out/Shinobi SDI in] and compatible batteries. Optional AtomX accessories including power and accessory kits are also available. Visit the Atomos website for the latest accessory options.

Included:

- 1 x Shinobi SDI
- 1 x AC Power Adaptor
- 1 x Quick Start Guide



2. What you also need

■ SDI Cables

SDI cables are robust physically and electrically. You should rarely have problems with signal transmission unless your cables are either damaged or too long. Please remember that SDI cables use locking connectors and will not simply pull out if they are jerked or tripped over. They are therefore a significant trip hazard, and also a hazard to your equipment, which may be damaged if the cables are mishandled or of a low grade.

■ HDMI cables

Make sure to use HDMI cables of the appropriate grade and take care to protect them from damage. Signal issues can often result from damaged HDMI cables, or using cables that are too long.

Atomos make a range of professional HDMI cables which are ideal for connecting between your camera and Shinobi SDI. We advise the use of Atomos HDMI 2.0 cables.



 Not all HDMI cables are created equal and there are a variety of different qualities available. Please make sure you test your cables prior to shooting.

Also check your connectivity at both the camera connector and the monitor connector to make sure you have a firm connection to avoid any signal drop out.

■ Standard 1/4" Mount/Arm

The Shinobi SDI unit includes 1/4"-20 screw mounts top and bottom. It is compatible with the latest mounting solutions from companies such as Shape, SmallRig and Wooden Camera. Select the mount type that best suits your input device, application and conditions.

Below are some examples of tripod and cold shoe mounts, available from most camera and video specialists.



A secure mount will greatly enhance usability and security of SDI and HDMI, power, remote and audio connections. Related info on page 10.

3. Powering the Shinobi SDI



Battery Eliminator
(included)



NP-F Battery
(optional)

Choosing your power source

The Shinobi SDI can be powered by the included AC-powered Battery Eliminator, or by using a compatible DC battery. If you are the owner of other Atomos devices, the batteries you have for these devices (NP-F series) will be compatible with your new Shinobi SDI.

Battery Eliminator

Included in the Shinobi SDI box is a Battery Eliminator. This connects directly to the battery slot of your Shinobi SDI and enables AC power connection. Please note the Battery Eliminator is suitable for use with Atomos devices only.

Batteries

We recommend the use of optional Atomos NP-F type batteries and the Atomos Power Kit with the Shinobi SDI. The Shinobi SDI can also use standard NP-F compatible batteries. Charge new batteries before using them, using a compatible battery charger. To attach the battery, gently slide it down into the slot until it locks into position. To remove a battery, push the latch to release it.

⚠ Before any type of disposal the battery should be discharged completely. Tape the contacts with electrical tape and package so as to prevent contacts accidentally coming together at any time.

⚠ Incineration must be performed by an approved and permitted waste treatment facility that handles lithium ion batteries. If you are not sure if your waste facility can handle lithium ion batteries, contact them and verify if they are permitted or not.

Atomos NP-F Battery Charger (optional)

The Atomos NP-F Battery Charger has been designed to rapidly charge the batteries yet be lightweight to travel with.

In the unlikely event of a charge error the first and fast red LEDs flashing quickly.

⚠ Fast charging of the battery is possible up to 80% capacity and the remaining 20% will then charge at a slower rate to maintain good battery life.

⚠ Batteries do not charge in a linear way. At first they charge very quickly, and then the rate slows down to a trickle. While charging, one or more red lights will blink. When 90% charge is reached, all the lights will flash. It is perfectly OK to use the batteries at this point and we recommend stopping at this stage for the longest battery life. If you leave the batteries on charge after all four lights are flashing, the charger goes into trickle charging mode for the final 10%. Eventually, when trickle charging is complete, and the batteries are at 100% charge, all the lights will go out.

Battery slot

Gently slide down into battery slot and lock into position

Push the release button to unlock the battery and slide battery upwards to remove.

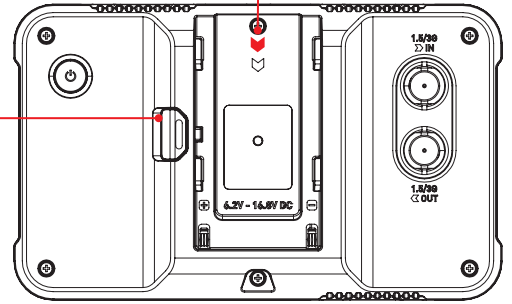

Choosing the right battery for your application

Battery time (Based on 7.4V)	Standby mode	Monitor mode
	2600mAh - 3hrs	2600mAh - 1.5hrs
	5200mAh - 6hrs	5200mAh - 3hrs
	7800mAh - 12hrs	7800mAh - 6hrs

ⓘ We recommend using Atomos NP-F series batteries.

⚠ Batteries and modular accessories are held in place tightly because they are on the outside of the device, this is to ensure there is no possibility whatsoever that they work loose, so you may have to be quite firm with the battery latches. We suggest that you familiarize yourself with the force required to remove the battery and accessories so that you can do this quickly in the field.

3. Powering the Shinobi

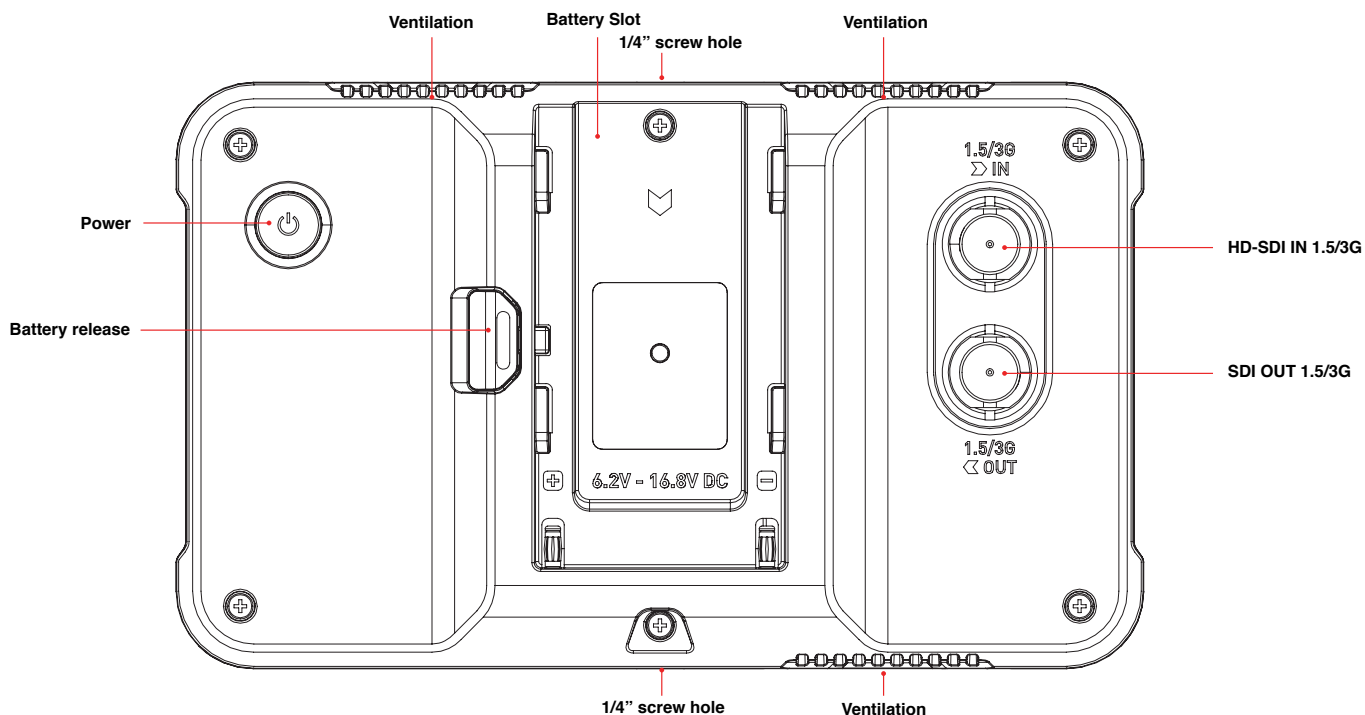

Turning ON power to the Shinobi SDI

The power button is located rear of the unit. With a charged battery or supplied battery eliminator attached momentarily press the recessed circular button to power up the unit. After a couple of seconds you will see the Atomos logo, and then the Shinobi SDI Home Screen.

Five seconds can seem like a long time! We've made it this way to make absolutely certain that the Shinobi SDI can't be turned off accidentally.

⚠ **Take note to respect the air flow and do not to obstruct the cooling vents of the unit.**

Turning OFF power to the Shinobi SDI

To turn the unit off, do a forced power down by **pressing the power button for five seconds**.

4. Shinobi SDI Connections

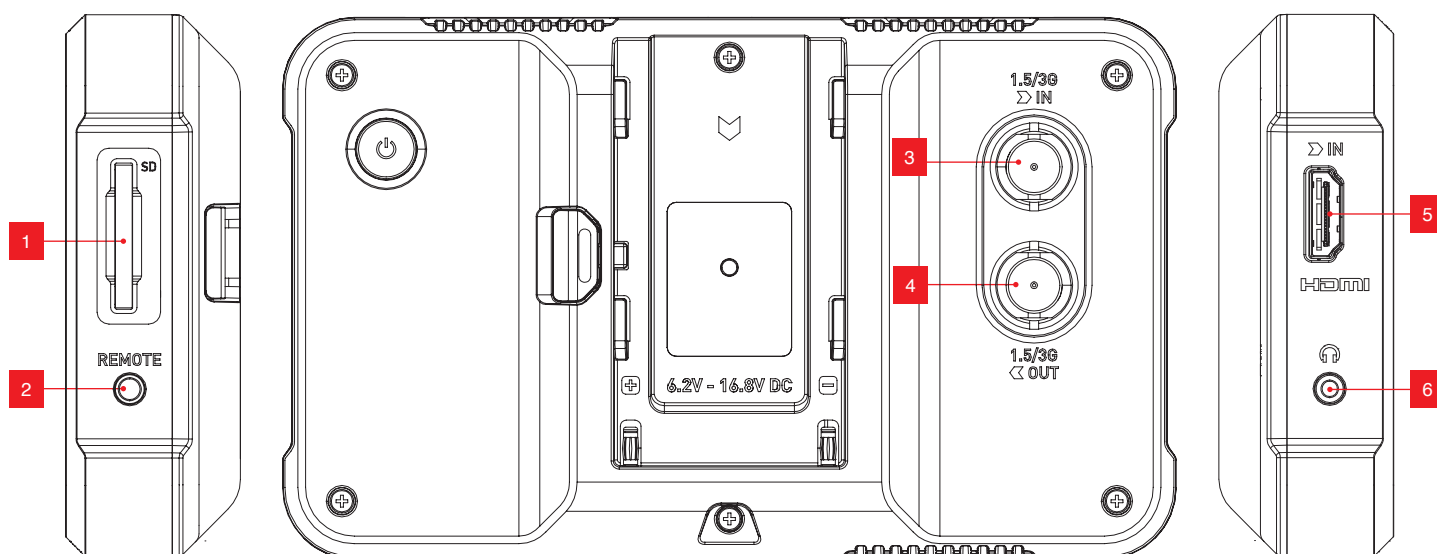

1. SD Card Slot

Use SD cards to load LUTs and/or update firmware.

2. Remote/Calibration Port

The remote 2.5mm jack on the right hand side (looking from the front), allows for the connection of the ATOMOS USB to Serial LANC cable to any computer device. An X-Rite i1Display Pro calibration device needs to be attached via USB to the same computer and then placed on your Shinobi SDI's screen*. The unit will only be calibrated when using the ATOMOS Calibration software.

The latest version of the ATOMOS Calibration software for the Shinobi SDI can be found at www.atomos.com/calibration

*For optimal calibration, it is recommended that your Shinobi SDI be powered up to 15 minutes prior to calibration.

3. HD-SDI in

The SDI input connections are 1.5/3G compliant and backward compatible meaning that it can be used for 1.5G & 3G signals. The SDI inputs support 3G in both A and B standards.

4. SDI out

This is for the connection to an external monitor or other device with an SDI input. It carries the incoming SDI signal in monitor or standby mode. This output can carry a HD signal. The SDI outputs support 1.5G & 3G in level A and level B standards.

5. HDMI in

The video input is a full-size HDMI 1.4a connection used to receive the video and when supported by your device embedded audio, this is both displayed to the Atomos monitor.

Embedded Audio: Most mirrorless cameras and camcorders send two channels of audio over HDMI which allows you to monitor audio via the headphone/audio out jack.

6. Headphone/audio out

A 3.5mm headphone jack is located below the HDMI port. Volume for headphone monitoring is via the on-screen audio controls menu, accessible by touching the audio meters in the upper right side of the touchscreen (monitoring mode) or in the bottom right of the screen (homescreen mode).

Mounting options

The Shinobi SDI unit includes 1/4"-20 screw mounts top and bottom, ensuring it is secure on gimbals, and compatible with the latest mounting solutions.

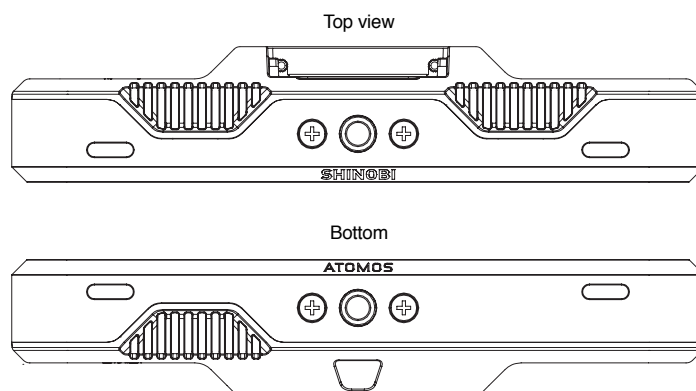

⚠ Ensure you do not over tighten the screw mounts as this may cause damage. Do not insert a 1/4"-20" thread longer than 5mm or you will risk causing damage to the chassis.

5. Using the Shinobi SDI - Best Practice

Understanding the basic controls and functions will save you time in the future. Before you start enjoying your Shinobi SDI it will help to review these simple procedures

a. Screen Lock b. Firmware Updates

a. Screen Lock

Lock the Display Screen

You can lock the display of the Shinobi SDI by tapping the power button. This will ensure no changes can be made by mistakenly touching the screen. The screen lock function will simultaneously lock or unlock the Shinobi SDI.

Short tap the power button again to unlock the unit.

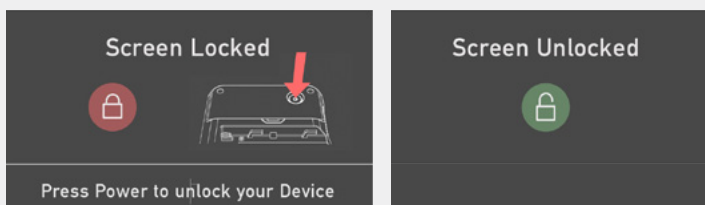
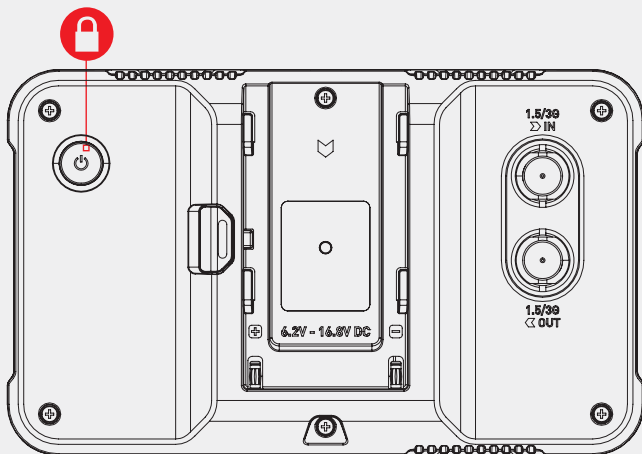

b. Firmware Updates (AtomOS)

From time to time we will issue software updates for your Shinobi SDI. To update the firmware (that's the software that runs inside your Shinobi SDI), there is a simple procedure you have to follow.

- Check your current Firmware version
Navigate to the Info tab by first pressing the input indicator and then navigating through the menu. The info screen contains the firmware version number and other important information about your Shinobi SDI. Determine if your device is up-to-date or if a firmware update is required.
- Go to www.atomos.com/support
- Locate and download the firmware upgrade

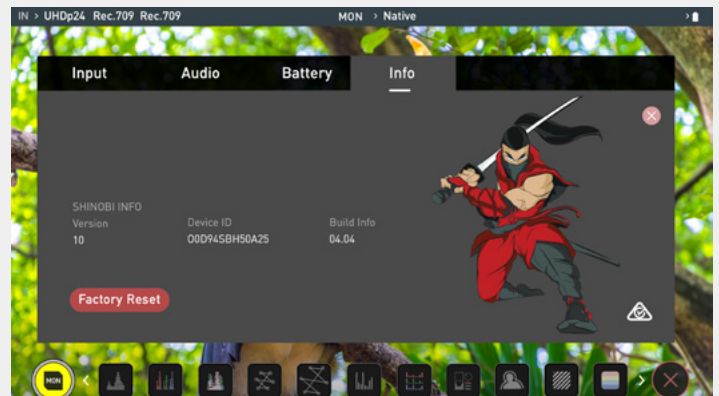

1. Extract the files ATOMSHBHF.bin and ATOMSHBHV.bin from the firmware zip file.
2. Copy these files onto a SD Card.
 - a. Atomos recommends you use a freshly formatted compatible SD Card (FAT32 aka. MS-DOS).
Note: the maximum SD card supported size is 32GB.
 - b. Ensure that the firmware update file is on the root of the SD card, and not in a folder or sub folder.
3. Use a freshly charged battery on your Shinobi SDI or connect to mains power. It is very important that your Shinobi SDI does not lose power during a firmware upgrade.
4. Power down your Shinobi SDI.
5. Insert the SD Card with the ATOMSHBHF.bin and ATOMSHBHV.bin files.
6. Power up your Shinobi SDI with a short press of the Power Button.
7. Watch the screen. The Atomos logo will appear, and then be replaced with a Please Wait message and after a few seconds the firmware upgrade will start.
8. While the firmware upgrade is happening, an 'updating firmware' screen will appear.

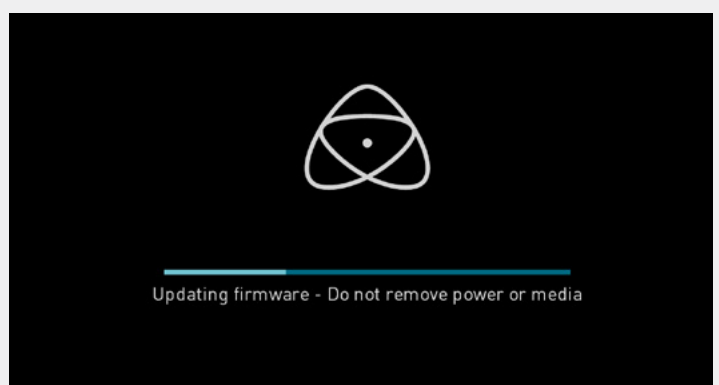

5. Using the Shinobi - Best Practice

9. The firmware upgrade may take several minutes.
10. When the firmware upgrade is finished, the Shinobi SDI will prompt you to restart the device.
11. Turn on your Shinobi SDI again with a short press of the Power Button.
12. When the Shinobi SDI has booted, return to Settings and then select the Info tab and check that the version number is the version expected.

IMPORTANT: Problems when installing AtomOS

Very rarely, the firmware update process can go wrong. This might be because of an incomplete or corrupted download.

In the unlikely event where the firmware procedure was not successful, please contact atomos support at www.atomos.com/support

 *Please ensure your batteries have plenty of charge and that you do not interrupt your Shinobi SDI while its firmware is upgrading. You will see a progress bar to the lower half of the screen. When it is finished, the Shinobi SDI will restart and you will be able to use the device as normal. This process can take up to 5 minutes.*

5. Using the Shinobi SDI

Setting up for monitoring

As soon as you connect a supported signal to the Shinobi SDI input the following will happen;

- The input source & format will be shown in the top left corner of the information bar
- Image will appear on screen
- Audio input meters will be responding to source.

Connected (monitor features mode)



No Input

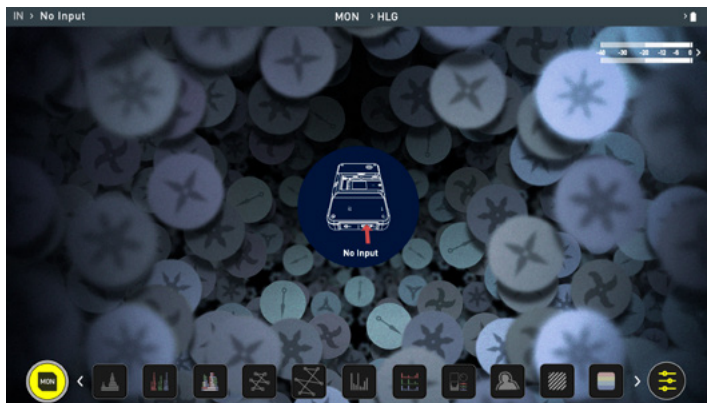

Connect to different devices

Video Cameras

Video Monitor: With the Shinobi SDI, users will be able to monitor their footage with a wide range of tools such as focus peaking, 4:1/2:1/1:1 zoom, Zebra, False Color, Frame guides, SMPTE Safe Area, Waveform, RGB parade, vectorscope and more.

The HDR feature supports log curves for many cameras in the market presenting a live preview of what the final image will look in post-production. The ability to load custom LUTs via the SD card input gives users the extra freedom to load in LUTs of their choice.

Cameras (DSLR/Mirrorless)

Use as a Video Monitor: When in movie mode users will be able to monitor their footage with a wide range of tools. Essential monitoring tools include:

- Focus peaking
- 4:1/2:1/1:1 zoom
- Zebra
- False Color
- Analysis (multi-tool view)
- Frame guides
- SMPTE Safe Area
- Luma parade
- RGB parade
- Vectorscope
- Histograms
- Blue only
- Anamorphic desqueeze

5. Using the Shinobi SDI

The Main Screen - Information Bar

At the top of the Shinobi SDI screen is the area referred to as the **Information Bar**. Info here relates to the settings of your input device/camera, Shinobi SDI, audio and more. Touching any of these areas will take you to the relevant menu. More info on page 11.

The content of the Information Bar is dependent on the settings from your input device. Your Shinobi SDI will automatically detect the incoming signal and display the information. To override any of the settings, simply tap on the info to access menu and info settings

Monitor Mode / Features



VIDEO INPUT:

Resolution and frame rate from input device

INPUT GAMMA:

This shows the gamma which should be set to be the same as the source device. Touch this control to ensure it matches the input coming from your source device.

INPUT GAMUT:

Shows current gamut input applied to the signal from the source device.

Touch this control to ensure it matches the output coming from your camera or other input device.

MONITORING MODE:

This shows the gamma which should be set to be the same as the source device. Touch this control to ensure it matches the input coming from your source device. During playback mode this setting will be determined by the recorded content.

AUDIO:

Audio Meters. Touching the audio meter will open the Audio settings menu

BATTERY:

Touch to access Power Menu. Battery Indicator shows power level and flashes red when power is running low.



MONITOR:

Tap to toggle Monitor Features Mode / Home Screen Mode. See page 12 for more information.

5. Using the Shinobi SDI

Input

Video Input

Simply tap the source input menu to the top left of the screen to bring up the input control panel. This panel is a command center for all devices connected to the Shinobi SDI and will assist you with connectivity by indicating if the signal is active or if attention is required.

SOURCE

Displays the input source currently connected to the Shinobi, simply tap to toggle between HDMI & SDI inputs. You can have both HDMI and SDI inputs connected at the same time and use this menu to toggle between active inputs.

CAMERA OUTPUT

For the best image processing results it is essential to adjust the Shinobi SDI camera output settings to match the format received from the connected camera. To enable selection of camera, gamma and gamut options first turn Log/HDR processing on.

Note: Shinobi does not support auto HDR Flagging.

Log/HDR: Turn on to enable HDR image processing inside the Shinobi SDI. Bring the control of post into your shoot - record, preview and review using HDR.

Camera: Tap to scroll through to the manufacturer of the camera providing the input. Sony, FujiFilm, Canon, Panasonic, ARRI, RED and JVC.

Log Gamma Format: For each manufacturer there may be a number of different Log curves available and you can scroll through to the correct selection by tapping the Gamma icon.

Gamut: Select the Color Gamut of the input. This is not applicable to all cameras but again ensure that this matches the input of the camera to ensure accurate monitoring.

VIDEO INPUT HDMI or SDI

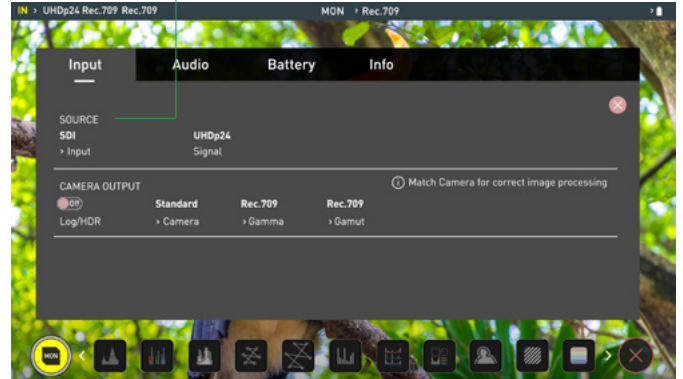

About Log/HDR

A better understanding of Log and HDR will enhance your workflow and ultimately allow you to capture maximum amount of detail during recording, and save you time in post production. To understand more about the importance of this function please see page 20.

5. Using the Shinobi SDI

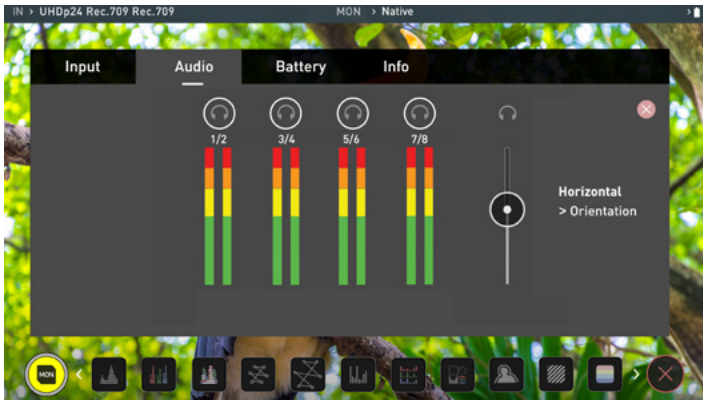

Audio

Audio

The audio settings are easily accessible by touching the audio meters (shown below) on the monitor screen.

Touching the meters will take you directly to the Audio menu where you can adjust output volume and select which channels you would like to monitor.

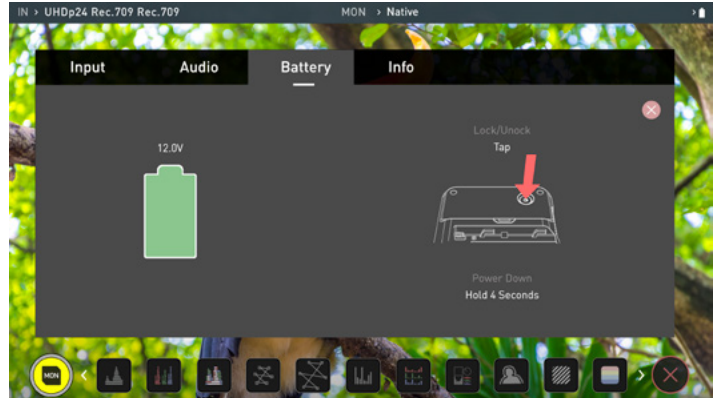
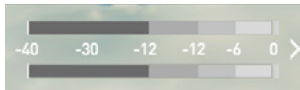

Battery

Battery

The Battery icon on the left of the screen indicates the remaining power in the attached battery.

When using the supplied Battery Eliminator, the remaining power indicator will remain green and show 100% full. The displayed voltage will be determined by the input source. Refer to your Shinobi SDI quickstart guide for more information regarding battery life.

 *When a battery is running low a message will appear on screen. Warning message will appear at approximately 6.3V remaining.*

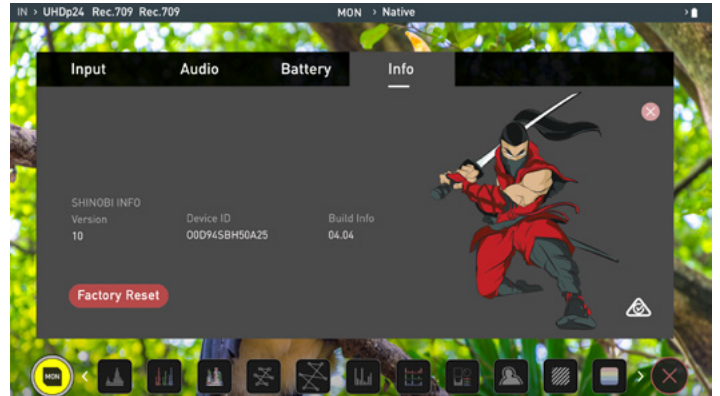

Info

Info

Shows the software (firmware) version and unique device ID (DID) of your Shinobi SDI device. You can check on the Atomos website to ensure you are running the latest firmware: www.atomos.com/support

5. Using the Shinobi SDI

The Main Screen - Monitoring Features

At the bottom of the Monitoring screen are the Monitoring Features, accessible by toggling the MON icon. Monitoring Features do not affect your recorded file and can be turned on and off, or adjusted whilst recording. Not all Monitoring features are available at first glance – to reveal all

Monitoring features, swipe monitoring icons to the left. The icons will behave in a carousel like manner and you can swipe left and right to access any of the features. At the bottom right is the Settings button. Press Settings to adjust behaviours of Monitoring Tools.

Monitoring Features



- | | | | |
|--|--|--|---|
| <p>MON (Monitor):
At this screen, press once to revert to home screen view. For Monitor settings press the Settings button. Any Monitoring functions you have enabled will remain active until deactivated.</p> | <p>Luma Waveform
A great way to visualize the dynamic range of your image.</p> | <p>RGB Histogram
Visualize the distribution of colors in an image.</p> | <p>Zoom 1:1
Punch in and check critical focus across 4K images.</p> |
| <p>SETTINGS:
Touch to access Monitoring Feature settings. Set your histograms, zebra and waveforms, adjust transparency, LUTs, Focus Peaking and more.</p> | <p>RGB Parade
Monitor the level of red, green and blue from an input source.</p> | <p>Analysis
Show video, waveform, histogram and vectorscope simultaneously.</p> | <p>Zoom x2
Punch in and check critical focus.</p> |
| | <p>RGB Overlay
Monitor the level of red, green and blue from an input source.</p> | <p>Focus Peaking
Ensure your recordings are always in focus.</p> | <p>Zoom x4
Punch in and check critical focus (x4).</p> |
| | <p>Vectorscope
This is useful for checking if an image is under or over saturated.</p> | <p>Zebra Pattern
Use Zebra to check exposure and set exposure levels.</p> | <p>Safe Areas
Action area and title safe areas displayed.</p> |
| | <p>Vectorscope Zoom
8x of the center of the vectorscope. Useful when setting white balance.</p> | <p>False Color
A visualization of exposure across the image</p> | <p>Cinema Guides
Cine or TV frame guides.</p> |
| | <p>Histogram
Visualize your exposure over the entire image.</p> | <p>Blue Only Exposure
Observe the noise content of a video image.</p> | <p>Anamorphic Desqueeze
Allows you to correctly view images when using anamorphic lenses</p> |

5. Using the Shinobi SDI

Using Waveform Monitoring tools (WFM)

Luma Waveform

The Luma or Luminance Waveform is a great way to visualize the dynamic range of your image, allowing you to protect exposure on both your highlights and shadow detail. It's particularly useful when shooting with a low contrast LOG curve and works in perfect partnership with HDR to illustrate the highlight clipping point to allow you to correctly expose your image.



RGB Parade

RGB Waveform will monitor the level of Red, Green and Blue from an input source. The RGB channels are displayed side by side and each channel color is shown under the corresponding waveform. This can be used to check the white balance. Just point the camera at something white and the Red, Green and Blue levels should match if white balance is setup correctly on the camera.

 *The Waveform Monitor will remain on screen when hiding the overlays ensuring the focus remains on calibrating your image. If the MON button is pressed the WFM will move in to the bottom icon line up.*



RGB Overlay

RGB Overlay monitors the level of Red, Green and Blue from an input.



Vectorscope

The Vectorscope display shows color information of hue (shown as a phase vector), and saturation (measured by outward distance from the center).

This is useful for checking if an image is under or over saturated and for calibrating multiple cameras to ensure greater consistency between shots.



Vectorscope Zoom

The Vectorscope Zoom shows a scaled up view (x8) of the center of the vectorscope.

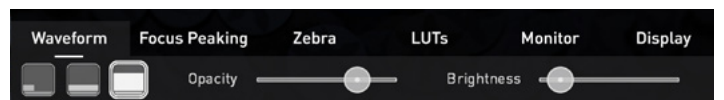

Waveform Monitor Settings

 To access Waveform Monitoring settings simply touch on the Settings icon and select the **Waveform Tab**.

To change the size of the waveform, press on the 1/4, 1/3 or Full Screen icons and the display will update immediately.



 *To toggle between Waveform Monitor sizes of 1/4, 1/3 and Full Screen during monitoring, recording and playback, tap in the bottom left corner of the screen. You can also adjust the brightness and opacity of the waveform display whilst monitoring.*

5. Using the Shinobi SDI

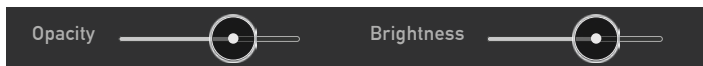

The Brightness slider directly controls the intensity of the waveform while the opacity slider adjusts the transparency values of the waveform display on screen. Experiment with these controls to achieve your desired monitoring setup.

Histogram

The histogram is a guide to exposure, it shows the range of tones present in an image. The horizontal axis of the graph represents the brightness level, with darkest shadows on the left to brightest whites on the right. The vertical axis shows how many pixels in the frame are at each brightness level. The graticule markers are shown for 0% Rec709(Black), 50% Rec709, 100% Rec709 (White). Please note that when using log signals from a camera, black and white will not align with the graticule markers.



RGB Histogram

RGB Overlay monitors the level of Red, Green and Blue from an input.



Analysis

The Analysis feature allows you to see Waveforms, Histograms and Vectorscopes simultaneously whilst viewing the image. Each of the displays can be toggled to customize the Multiview to suit your preferences. Toggle Luma Waveform with RGB Parade and RGB Overlay. Toggle Histogram and RGB Histogram for your desired settings, and Toggle Vectorscope and Vectorscope Zoom to accurately check your white balance. Analysis mode also allows you to control the brightness of the waveform and vectorscope displays, while constantly displaying the subject. Instant control at your fingertips.

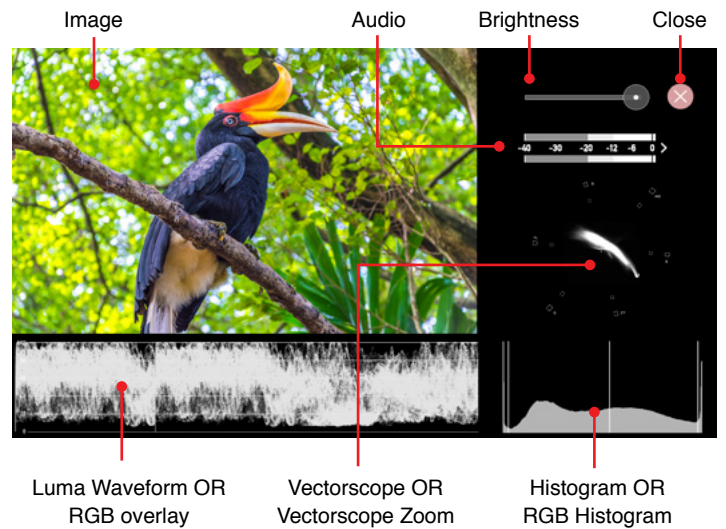

5. Using the Shinobi SDI

Using Monitor Assist tools

AtomOS10 features monitoring tools that help with making your shot picture perfect. Easily access Focus Peaking, Zebra, False Color and Blue Only Exposure to check image is in focus, noise free and correctly exposed. Options for safe area/title area markers along with aspect ratio markers and anamorphic desqueeze functions are also available.

Focus Peaking

Focus peaking allows the user to ensure their recordings are always in focus. The parts of the image in focus are highlighted by the selected color (can be adjusted by dragging the slider). There are a number of options for how peaking is displayed, it can be overlaid over the color video image, over a greyscale image or just show the peaking by selecting the corresponding icon.

Focus Peaking Color

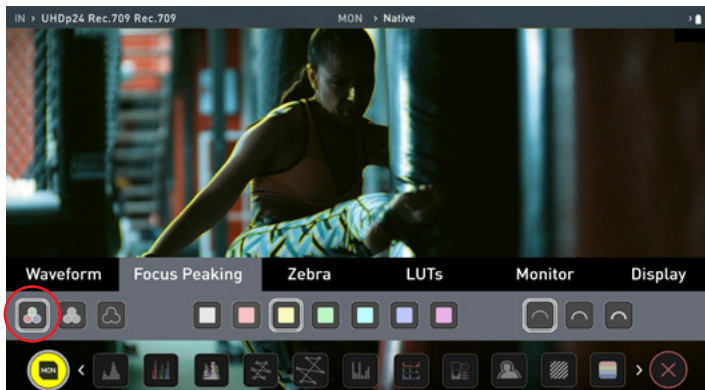

Focus Peaking Mono

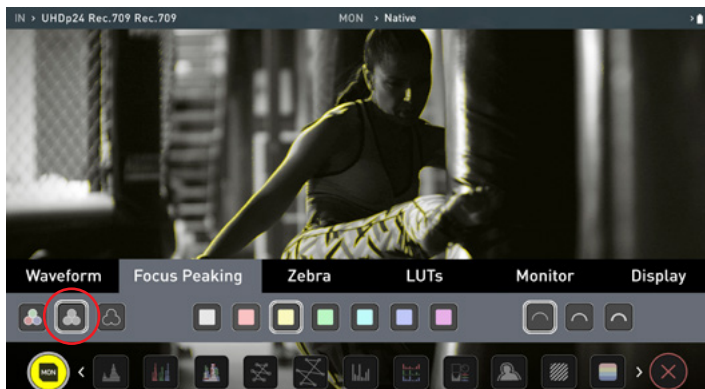

Focus Assist Outline

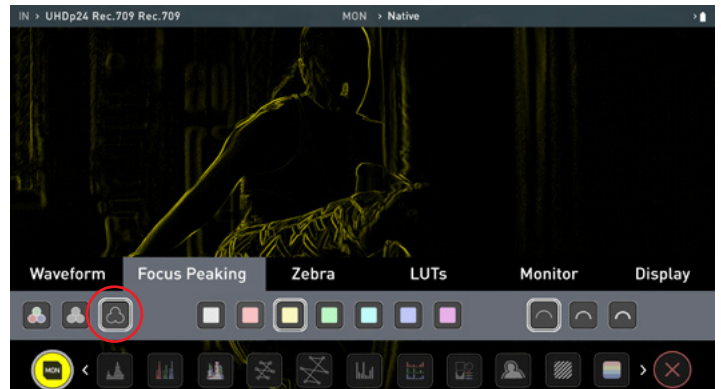

You can change the focus peaking colors modes and width by touching the icons in the focus peaking menu.



Zebra Threshold

Zebra pattern show the parts of the image that are exposed $\pm 5\%$ of the target level set. The Zebra threshold value can be adjusted by moving the slider left or right.

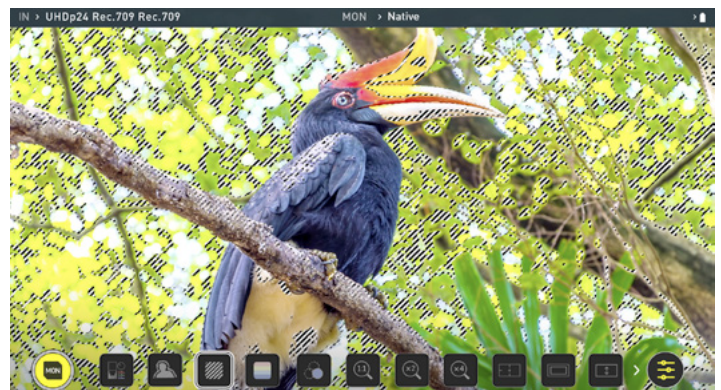

False Color

False Color assigns different colors to areas of different brightness in the image. This gives a visualization of what is going on with exposure across the image. There is a scale on the left hand side, overexposed elements will display as red, and underexposed elements will display as blue.

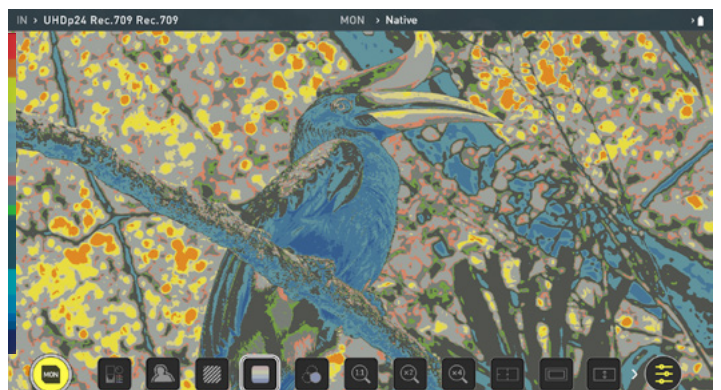

5. Using the Shinobi SDI

False Color Scale

To help you determine the exposure range with more accuracy, please use the scale on the left hand side of the display.

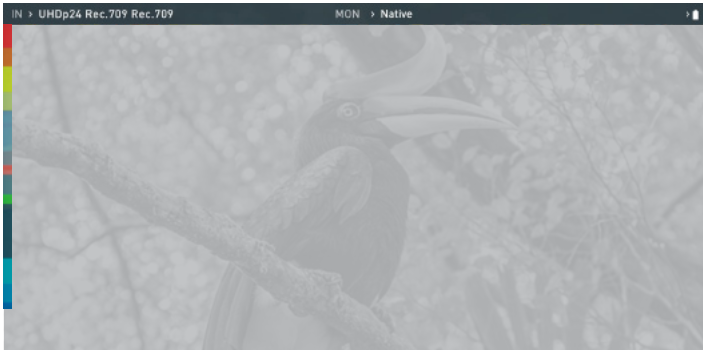

Blue Only Exposure

Blue only displays a greyscale image based on the blue channel of the input signal. This is useful to observe the noise content of a video image as sensor noise is most visible in this channel.



Zoom

Zoom mode enables you to punch in and check critical focus



Toggle 1:1 to display 1:1 pixel mapping, the indicator box shows the location of the screen you are viewing.
 • 4K 1:1 shows 1/4 of the 4K UHD image.



Toggle 2:1 to magnify the screen, the indicator box shows the location of the screen you are viewing, you can move the zoomed location by dragging across the screen or selecting a portion of the indicator box.



• 4K 2:1 shows 1/16 of the 4K UHD image.



Cinema Guides / Safe Areas / Anamorphic De-Squeeze

AtomOS 10 has advanced frame guides and safe areas. You can cycle through your required cine or TV frame guides by repeatedly pressing the guides icon. Action safe area and title safe areas can then be turned on and are proportional to the frame guides based on SMPTE standards.



Cinema Guides

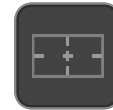

Safe Areas



Anamorphic De-Squeeze

To enable the guides press the Cinema guides icon to cycle through your chosen aspect ratio. The aspect ratio markers are very useful with the 2 x Anamorphic De-Squeeze to preview and crop what could be made in post. To turn on the safe area markers tap the Safe area icon once for the Action area and again for the title safe area.

Cinema Guides



 The Safe Area/Grid Lines will still be visible when tapping the center of the screen to hide the overlays.

Safe Guides

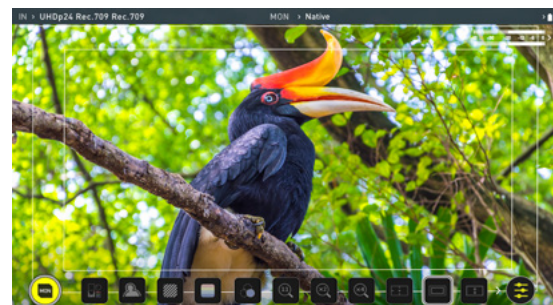

Desqueeze 2x

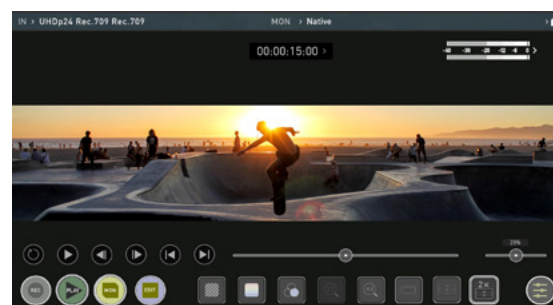

5. Using the Shinobi SDI

LUTs

A LUT or Look Up Table is a table that transforms the color response, and as such adjusts the 'Look' of the input. 3D LUTs have a combination of three inputs defining the combination of R, G, and B (red, green & blue) values; allowing for adjustment of color, gamma and gamut. LUTs can also be used to create a specific 'look' such as to match cameras or emulate film stock.



Atomos support 3D LUTs in the industry standard .cube format and provides up to 8 LUT memory slots for you to load your LUTs in to.

It's worth noting that not all LUTs are equal and the majority of LUTs are designed to work within the boundaries of REC.709. This means that whilst they may apply the color adjustments you are looking for, they may also effect the luminance of the image and in which case these LUTs should only be used for delivery of content designed to be viewed in REC.709 or SDR. If you are working with 3D LUTs you can use color correction applications, as well as applications like Davinci Resolve, Photoshop or dedicated applications like LUTCalc. to create your own custom Looks that can then be imported to your Atomos device. They can provide a great base or primary grade that allow you to apply an instant look to your footage.

Atomos support 3D LUTs in the industry standard .CUBE format and provides 8 LUT memory slots for you to load your desired LUTs. 1D LUTs are not supported and will need to be converted via 3rd party software to be imported.

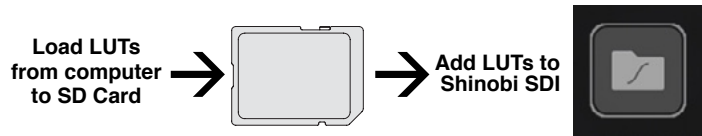

To import a LUT into your Shinobi SDI, first copy the .cube file onto a compatible SD card (**FAT32 aka MS-DOS formatted, maximum capacity 32GB**). Once copied, insert the SD Card into the SD port of the Shinobi SDI.

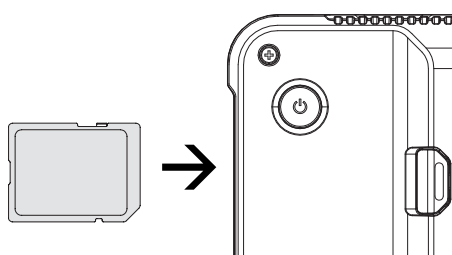

Ensure correct orientation

To load a LUT, select the desired slot (log curve button) and press any log curve icon; tap the folder file icon (load) and when the screen prompt appears, press the 'Confirm' button. Navigate the disk file system to the LUT file to be uploaded, press on the name to select the LUT and then press 'Load LUT' on right-hand side of your Shinobi SDI.

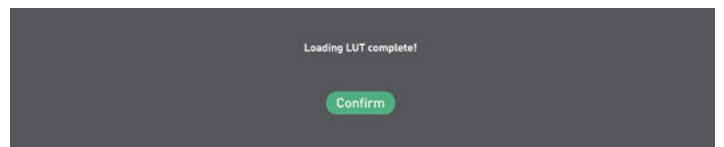
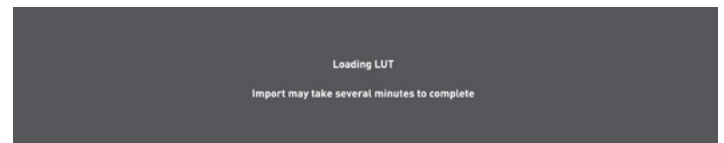
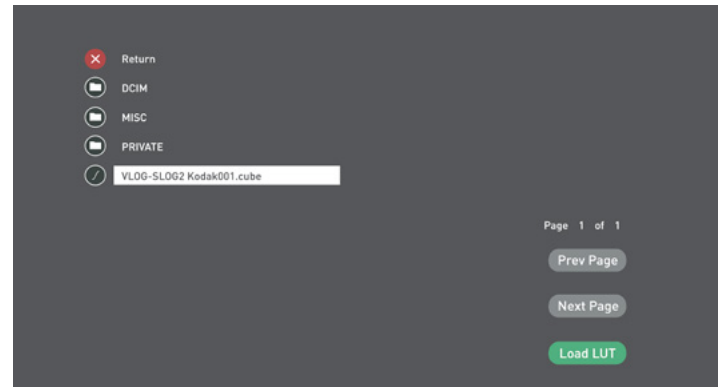
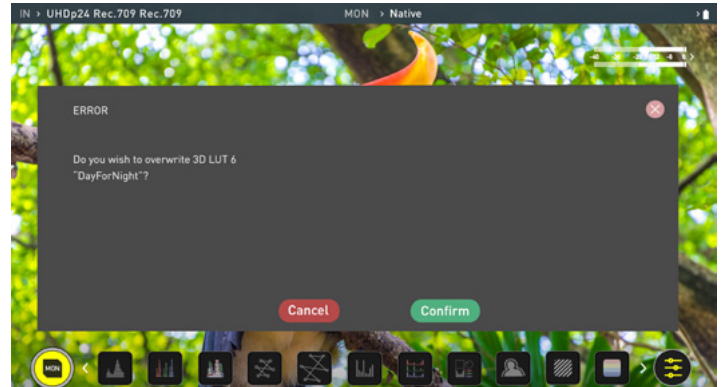
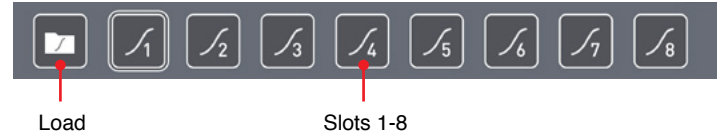

Activate the loaded 'LUTs' in the **LUTs** tab of the Settings menu; this LUT can then be applied to the display by navigating to the **Monitor** tab and activating the LUT option. Activating the LUT in the Monitor tab will always use the LUT selected in the LUTs menu. Touching the activated LUT name in the Information bar will give you instant access to the 'Monitor Menu'. Inside the LUTs menu, touching the preferred slot will preview the name of the selected LUT in the MON area of the Information bar.

The name of the selected 3D LUT will be displayed in the MON area of the Information bar.

5. Using the Shinobi SDI

LUT options:

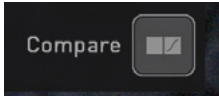

Compare

During color management it's likely that you may want to review a number of LOOKs and even compare them to the Native Video Source. Tapping the Compare option will apply a 50/50 vertical screen split that will show both the Natural Source Video and the selected LOOK of the LUT.

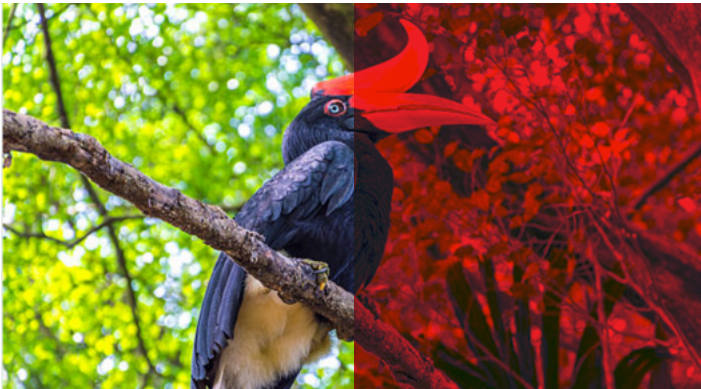

 Remember by simply tapping the center of the screen you can remove all overlays. Tap again to reveal controls.

Monitor

Before entering into the operation of HDR monitoring it is important to understand the background of HDR. We advise that you read the Atomos HDR Guide to familiarize yourself with the key terms and differences between the existing Rec.709 standard dynamic range (SDR) and the future way we will view images in High Dynamic Range (HDR).

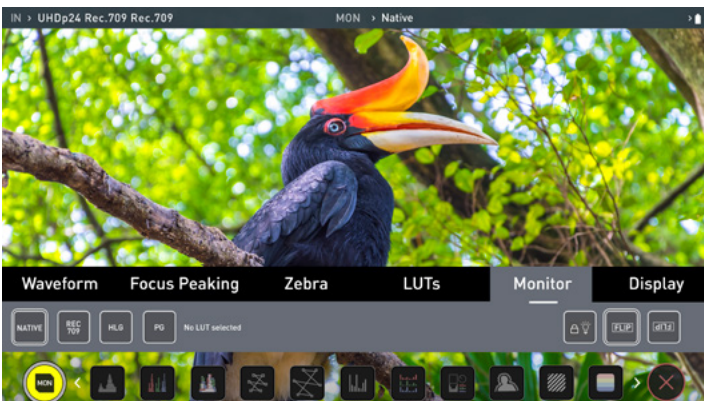

Using Standards - Native / Rec.709 / HLG / PQ

AtomOS 10 uses predefined settings to display your video when viewing in HDR. This is similar to the HDR slider in previous Atomos operating systems, except instead of a variable slider control, we have now buttons that correspond with Rec.709 (SDR), HLG and PQ (HDR) levels. Activating these buttons will display your video according to the levels indicated below, allowing you to adjust your exposure accordingly and take the guess work out of exposing correctly for HDR.



Native Video Source

This option will display the video source without any processing and the Shinobi SDI will behave as expected for a standard broadcast monitor. When connected to a camera this means the image you are viewing is the untouched camera output eg. a standard Rec.709 image or a Log image etc. A standard Rec.709 image will look correct and a Log image will look flat.



Rec.709

With this mode selected the Shinobi SDI will map from the camera gamma/gamut so that 100% linear IRE maps the panel's white (1000nits). Everything above is clipped.



HLG (Hybrid Log Gamma)

With this mode selected the Shinobi SDI will map from the camera gamma/gamut so that 1200% linear IRE maps the panel's white (1000nits). Highlights are slightly compressed.



PQ

With PQ mode selected the Shinobi SDI will map from the camera gamma/gamut so that 2000% linear IRE maps the panel's white (1000nits). Highlights have more compression and look similar to HLG, but closer inspection will reveal more detail is visible in specular highlights.

Your camera's dynamic range will determine how much more detail is visible between HLG and PQ modes.

5. Using the Shinobi SDI

Understanding HDR and Log

The first step in HDR is to recognize you have a HDR scene. Look for a good range of contrast across the brightest and darkest parts of your image and also across the color and tonal range as each color also contains its own brightness or luminance information.

Secondly ensure you are sending a Log signal into the Shinobi SDI so that you are recording the HDR Log information (See page 19 for more info).

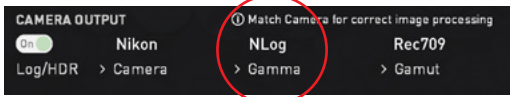

Now you are ready to capture Log and simultaneously use AtomOS10 image processing to preview the final HDR result in the field, rather than dealing with the washed out look of Log for critical exposure decisions.

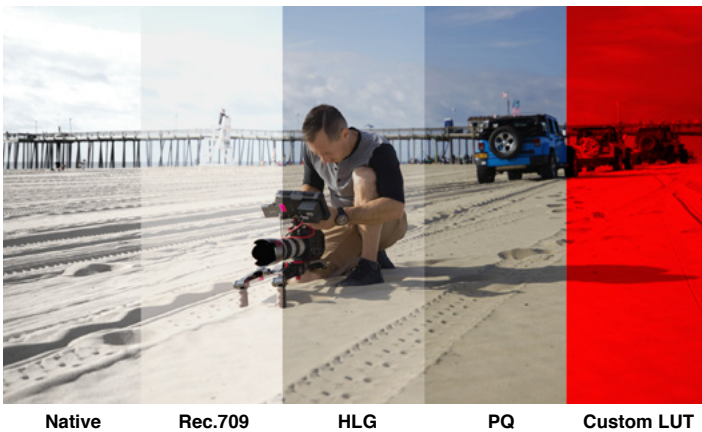

The main impact of HDR is apparent in the specular highlights and bright areas. The areas that would have previously been 'blown out' will now contain visible detail and information to enhance your content. HDR provides more headroom allowing you to show more detail. Experimentation with increased exposures is encouraged.

AtomOS10 HDR uses an in depth understanding of each Log curve and combines it with the control of the panel processing and backlight in order to apply an increased brightness to the highlight areas of the scene.

Alongside the physical light in the scene, the faster/brighter your lens the greater the level of brightness you'll have to play with. Choosing a Cine style lens or those with a declicked manual aperture can provide increased flexibility over photo lenses that use an electronic control aperture.

The AtomOS10 monitoring mode allows the processing engine of the Shinobi SDI to display the High Dynamic Range capabilities of a Log gamma input. HDR monitoring in AtomOS10 is the result of the research and development by Atomos that allows control of all aspects of the monitor through image processing to deliver the unclipped beauty of specular highlights through natural, vibrant colors with a result that allows you to simply shoot what you see. When the scene in front of you and the picture displayed on the Shinobi SDI look similar, your exposure should be correct but use in conjunction with the waveform monitor to verify.

One of the key elements to understand is that if your camera can shoot in Log then it can already capture the more dynamic range than you can display in SDR. Log preserves the highlight information by applying a Logarithmic curve to compress the additional stops of dynamic range to fit in to the Rec.709 standard. The image appears washed out and desaturated as each pixel contains more brightness information than SDR can display, if it were to do this it would be brighter than 100% Rec709 and so be clipped. This is illustrated below:

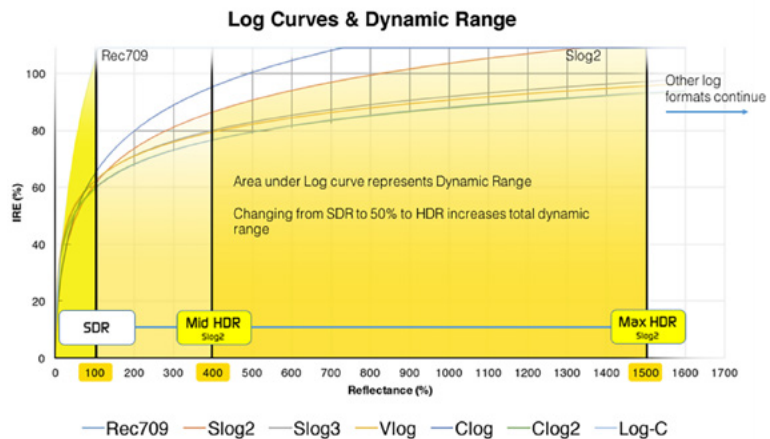

In addition to the SDR/HDR adjustments you have the following options:



The **Display off** function allows for the screen to be turned off without affecting the operation of the unit. This is combined with the screen lock function and will become active by tapping the power on/off button on the side of the unit.



The **Flip screen** option allows you to invert the screen to meet your needs of operation.

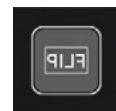

The **Screen Mirroring** option allows you to 'mirror' the screen. This function is particularly useful when 'self monitoring'.

If screen is inverted take note to respect the air flow and not to obstruct the cooling vents of the unit.

5. Using the Shinobi SDI

Display

With this mode is selected you have the option to change the screen brightness by adjusting the slider when in Native mode. As you slide to the right, the brightness will increase. When the screen is at 100% brightness, the image will be using the full 1000nits of the display. As with any electronic screen device, increasing the brightness will increase the power draw and battery life will be affected accordingly.

Adjustments can also be made to the Lift, Gamma and Gain of the display. You can tap the icon on the left of the menu to scroll through the options and adjustments are again made by moving the slider left and right.



Backlight:

Adjust the strength of the backlight. Disabled during HDR monitoring

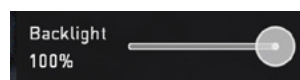

Lift:

Increasing lift will brighten the image and lessen the shadows



Gamma:

Gamma control allows you to create darker and richer shadows. This may be useful when monitoring in bright daylight conditions.



Gain:

Gain will boost the image brightness and affect the highlights



Reset:

Quickly return all values to default



8. Technical Specifications

Weight and Dimensions		
Without batteries	226g / 7.8oz.	
Dimensions (W x H x D mm)	151 x 91.5 x 31.5mm	
Construction	Polycarbonate ABS	
Mounting points	1/4"-20 screw mount. 1x top and 1x bottom	
Power		
Operating power	4-7W	
Compatible batteries	NP-F series and supporting accessories. AtomX or other.	
Input voltage (battery)	6.2V to 16.8V	
Battery time* (based on 7.4V)	Standby 2600mAh - 3hrs 5200mAh - 6hrs 7800mAh - 12hrs	Monitor 2600mAh - 1.5hrs 5200mAh - 3hrs 7800mAh - 6hrs
	DC In via Battery Eliminator	
Touchscreen		
Size	5.2"	
Resolution / PPI	1920 x 1080 / 427ppi	
Aspect ratio	16:9 native	
Color Gamut	Rec709 HDTV	
Bit depth	10-bit (8+2 FRC)	
Brightness	1000nit (+/- 10%)	
Look up table (LUT) support	3D LUT (.cube format). Extended support planned	
Anamorphic de-squeeze	2x, 1.5x, 1.33x	
Technology	IPS panel (capacitive touch), calibration to Rec.709 with optional calibration unit	
AtomHDR	Yes	
HDR Monitoring (Gamma)	Sony SLog / SLog2 / SLog3 Canon CLog / CLog2 / CLog3 ARRI Log CEI160 / LogCEI200 / LogCEI250 / LogCEI320 / LogCEI400 / LogCEI500 / LogCEI640 / LogCEI800 / LogCEI1000 / LogCEI1280 / LogCEI1600 Panasonic Vlog JVC JLog1 RED Log3G10 / RED LogFilm FujiFilm F-log Nikon N-Log PQ10k HLG	
	Sony SGamut / SGamut3 / SGamut3.cine Canon Cinema / DCI P3 / DCI P3+ Panasonic V Gamut Arri Alexa Wide Gamut Rec709 / BT.2020 JVC RED WideGamut / RED DragonColor / DragonColor2 / RED Color2 / RED Color3 / RED Color4 /	
Screen Mirror/Flip	Horizontal Flip (Selfie mode), Vertical Flip Landscape/Portrait mode planned †	
Anti-reflective	Special AR coating and Anti-fingerprint technology	
Video Input		
SDI	1 x HD-SDI 1 3G/1.5G	
HDMI	1 x HDMI (1.4)	
Signal	Up to Uncompressed true 10-bit or 8-bit 422 (camera dependent)	
Video Output (Playout)		
SDI	1 x HD-SDI 1 3G/1.5G	
Supported Loop-out Formats (SDI to SDI)		
2k DCI 2048 x 1080	23.98p, 24p, 25p, 29.97p, 50p, 59.97p	
HD 1920 x 1080	23.98p, 24p, 25p, 29.97p, 50p, 59.94p	
HD 1280 x 720	50p, 59.94p	
Audio In (48kHz)		
HDMI	2ch. 24-bit 48kHz	
SDI	8ch 24-bit 48kHz	
Audio Out		
Headphone out	3.5mm Headphone out 2ch.	
SD Card Slot		
Full size SD Card slot	SD Card Slot allows LUTs to be loaded to the unit and is also used when updating AtomOS firmware	

AtomOS	
Monitoring Features	Luma Waveform, RGB parade, RGB Overlay, Vectorscope, Vectorscope Zoom, Histogram, RGB Histogram, Analysis view (Multi-tool scopes: Waveform, Histogram, Vectorscope), Focus Peaking, Zebra, False Color, Blue Only Exposure, Zoom (1:1, 2:1, 4:1), SMPTE Safe Areas, Cinema Guides, Anamorphic Desqueeze.
What's in the Box	
Included	Shinobi SDI unit, 12V-15W AC power supply, Quick Start Guide
Optional Accessories	
Compatible optional accessories	Power Kit: 2 x NP-F Batteries, 1 x Charger, 1 x Power supply AtomX 5" Cage for Shinobi SDI (by SmallRig) AtomX 5" Sunhood (compatible w. Shinobi SDI / Ninja V) AtomX 5" Screen Protector (compatible w. Shinobi SDI / Ninja V) AtomX 10" Arm & Quick Release Plate (by Lanparte) Other: Atomos HDMI cables Xrite i1 Display Pro Calibrator and USB to Serial cable AtomX 5" Accessory Kit
Warranty	
1 Year from date of purchase	The main product, not including the IPS screen.

Construction note: Shinobi SDI is designed to operate in ambient temperatures up to 40°C/104°F. If you wish to extend the temperature of operation in high temperature conditions, set the TFT brightness to a minimum.

Please note: Specifications are subject to change without notice. All information correct at time of publishing.

