

H4essential

Handy Recorder

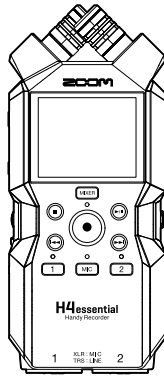

Quick Tour

Software and documents related to this product can be found at the following website.



zoomcorp.com/help/h4essential

You must read the Usage and Safety Precautions before use.

© 2024 ZOOM CORPORATION

Copying or reprinting this manual in part or in whole without permission is prohibited.

You might need this manual in the future. Always keep it in a place where you can access it easily.

The contents of this manual and the specifications of the product could be changed without notice.

Proper display is not possible on grayscale devices.

Inserting microSD cards

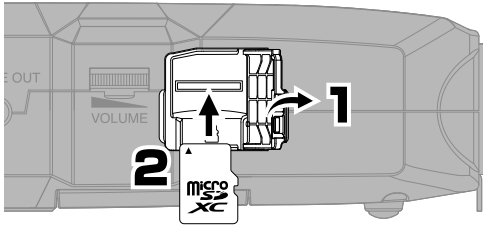

Supported recording media:

microSDHC: 4 GB – 32 GB

microSDXC: 64 GB – 1 TB

We recommend using microSD cards that have been confirmed to operate with this product. See the ZOOM website (zoomcorp.com) for information about microSD cards that have been confirmed to work with this unit.

- Always turn the power off before inserting or removing a microSD card.
- To remove a microSD card, push it further into the slot and then pull it out.

Turning the power on

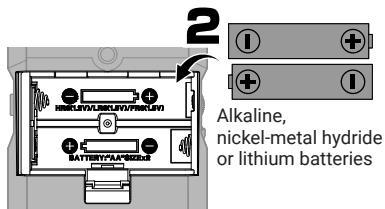
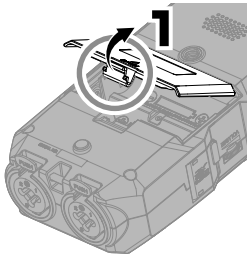

Alkaline,
nickel-metal hydride
or lithium batteries

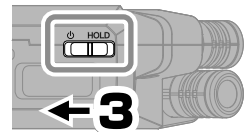

Open while pressing up.

Power can also be supplied through the USB (Type-C) port by connecting a commercially-available portable battery or a dedicated AC adapter (AD-17).

Making settings when first turned on

Use  (select) and  (confirm/execute) according to the screen.

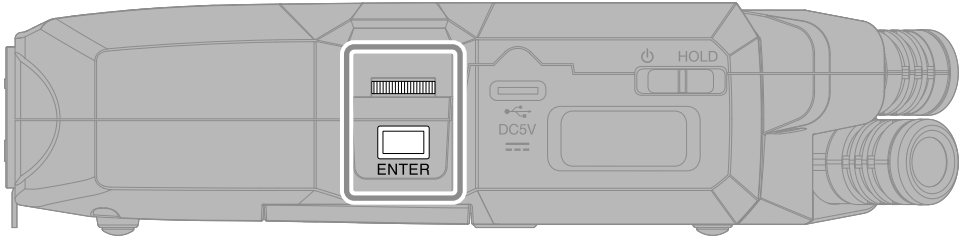



Accessibility setting

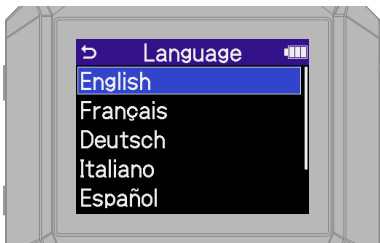

A function that can enable audio guidance and beep sounds is included to assist use by people with vision impairments.

Language setting



Press  to return to the previous screen.

Date format setting

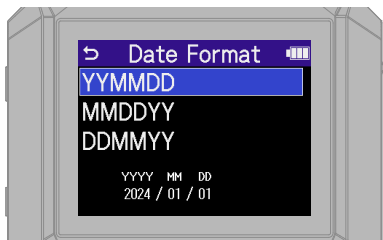

The year, month and day will be used in recording file names in the order set here.

Date and time settings

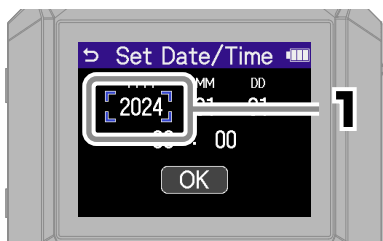

Select a setting item and confirm.

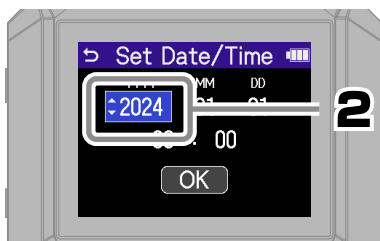

Change the value and confirm.

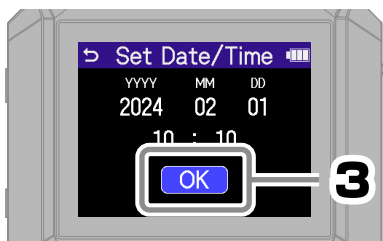

After setting all the items, select "OK" to complete setting the date and time.

Battery type setting

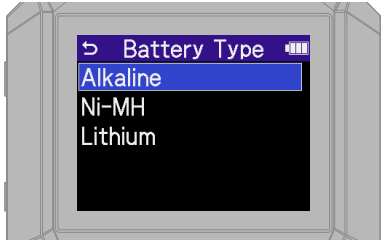

We recommend running SD card tests on microSD cards after purchasing them new or using them with a different device.

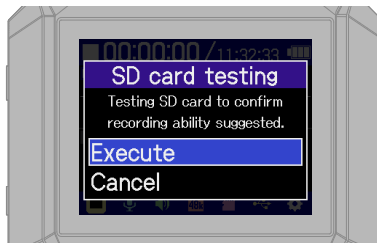

After settings are complete, the Home Screen will open.

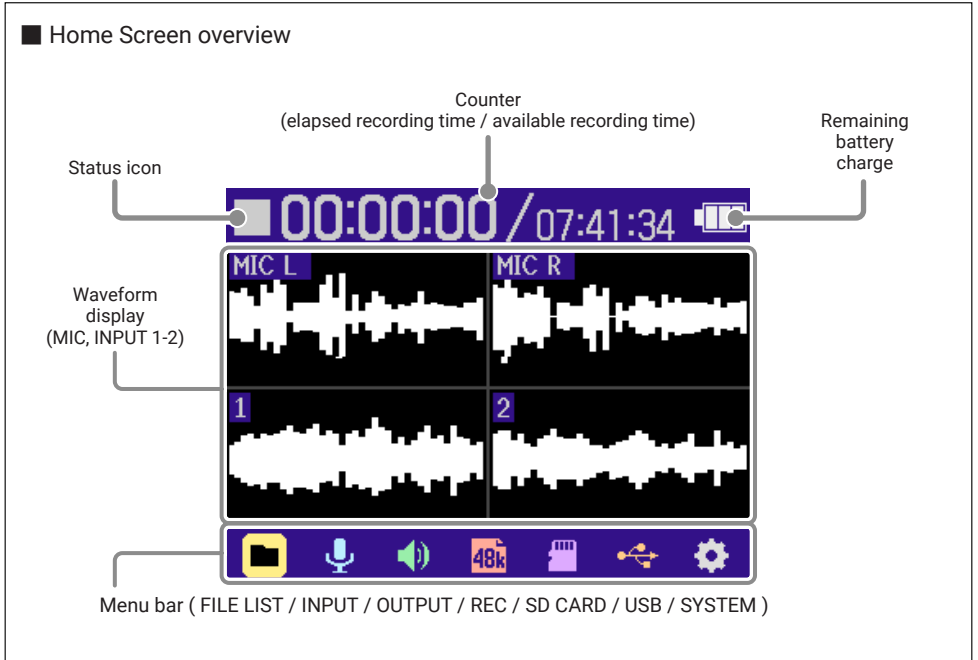

Preparing to record with the XY mic

■ Enabling tracks

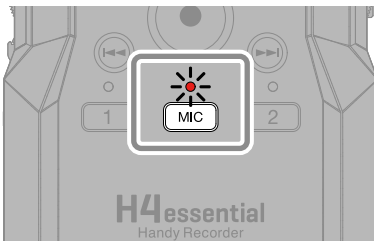

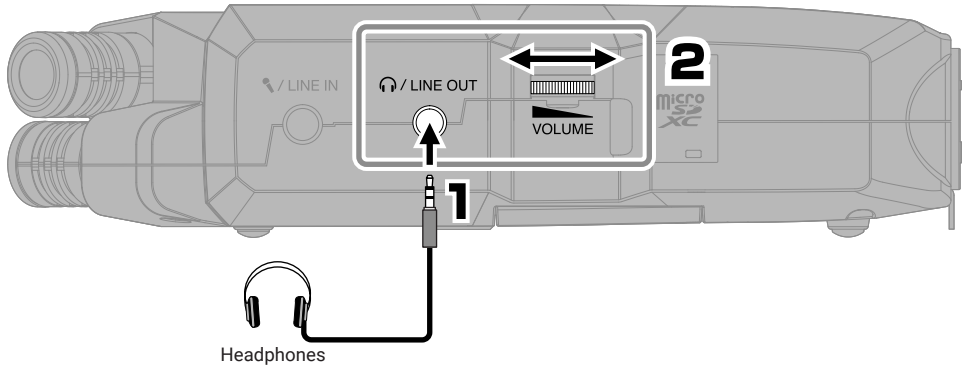

The indicator will light red, showing it is ready to record.

■ Connecting headphones and adjusting the volume

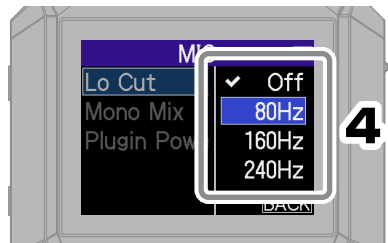
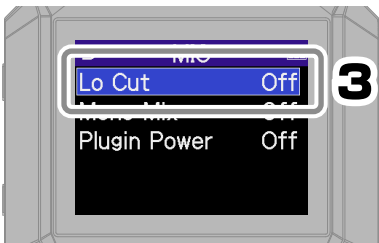

■ Reducing noise from wind and vocal pops



 can be pressed to return quickly to the Home Screen (from most screens).

■ Tip to improve recording sound quality

If the H4essential is placed directly on a table, reflected sound can interfere with recording and reduce clarity. We recommend using a tripod, for example, to distance it from the table. Placing a handkerchief, for example, can also be effective in reducing sound reflected from a table.

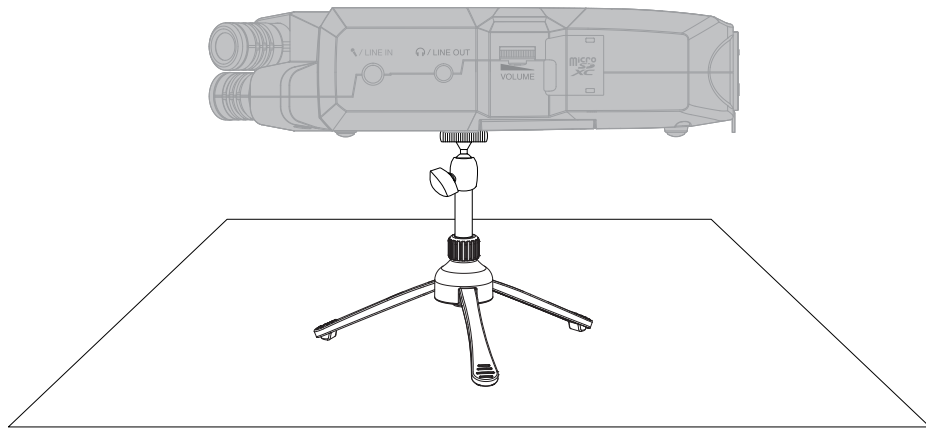

■ Using external mics

An external mic or line-level device can also be connected to the MIC/LINE IN jack and recorded. This can also provide plug-in power to mics that use it.

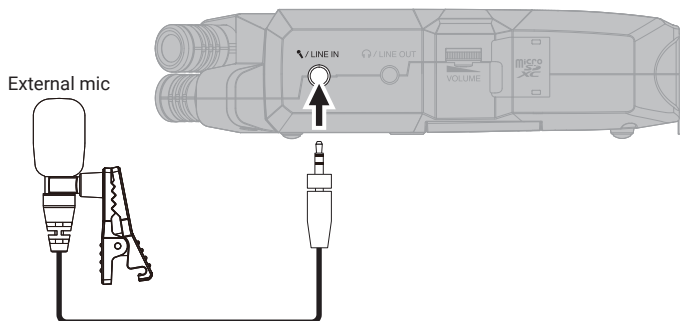

Preparing to record with inputs 1–2

■ Connecting dynamic/condenser mics

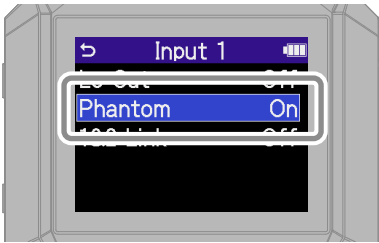
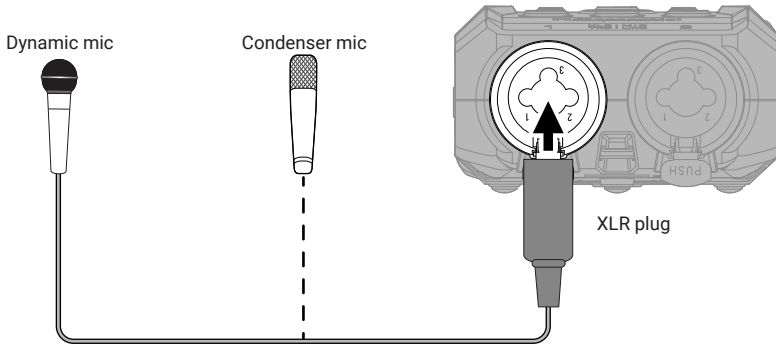

Turn on phantom power for inputs that have condenser mics connected.

When disconnecting an XLR plug, pull it while pushing **PUSH** on the connector.

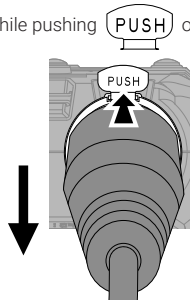

■ Connecting wireless mics

If the receiver output jack is stereo mini, use an adapter for XLR conversion.

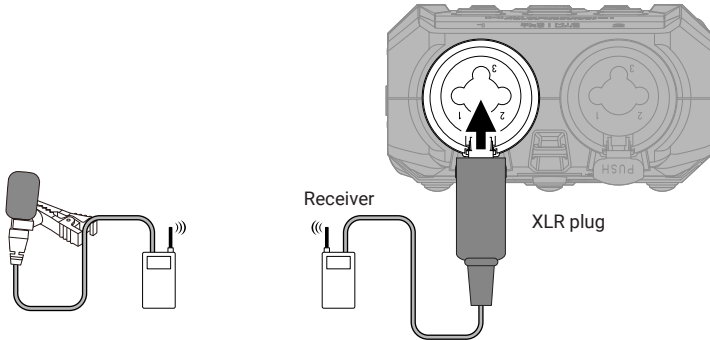

■ Connecting mixers and other line-level equipment

Use a cable or adapter so that a TRS plug is used to connect to the H4essential.

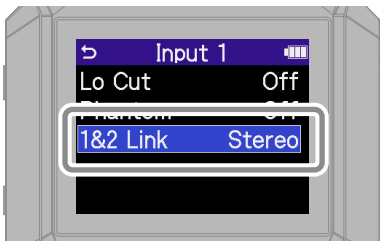
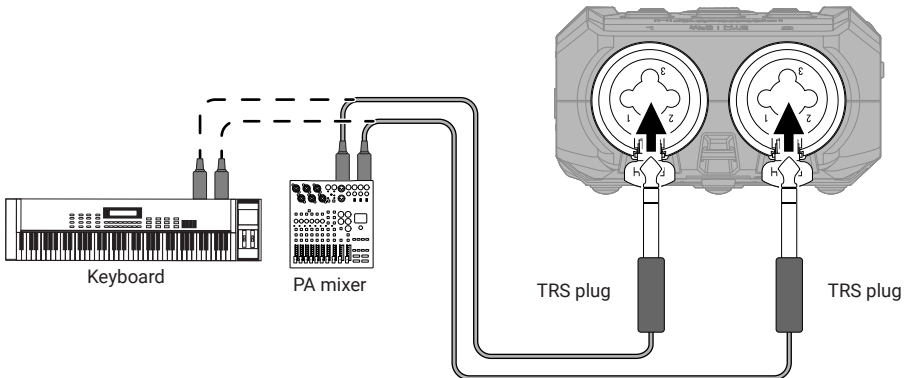

When stereo-linked, tracks are recorded as a stereo file with track 1 on L and track 2 on R.

■ Adjusting the monitoring mix

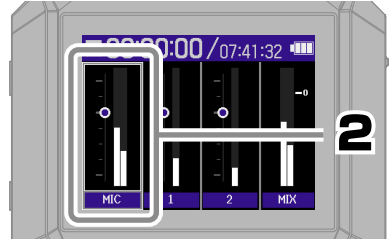
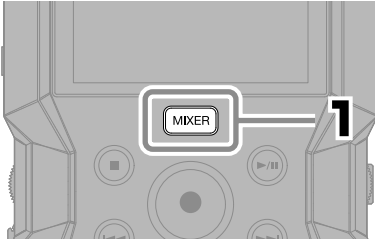

Select a track and confirm.

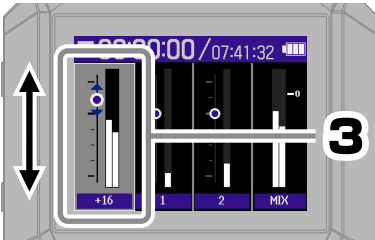

Adjust the monitoring balance and confirm.

Press **MIXER** to return to the Home Screen.

Recording

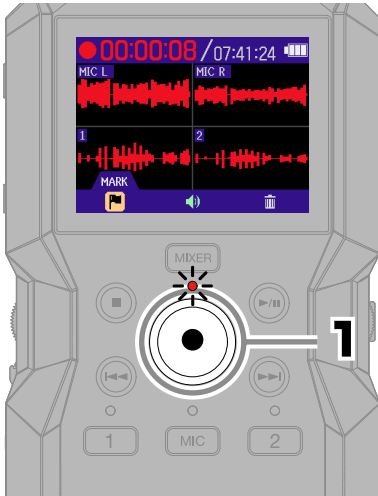

The indicator will light red and recording will start.





This ends recording.

Slide  toward HOLD when recording to prevent misoperation.

■ Using the Recording Screen



 MARK	This adds a marker for cueing during playback.
 OUTPUT	Use this to set the line output level.
 TRASH	This stops recording and moves the file to the trash.





Playing recordings



This starts playback.

■ Using the Playback Screen



	FILE LIST	This opens the FILE LIST Screen.
	AB REPEAT	Use this for repeat playback of a specified range (A-B).
	OUTPUT	Use this to set the line output level. Use this also to normalize the audio and set the playback speed.
	EXPORT	Use this to convert and export files.
	TRASH	This moves the file to the Trash.

Accessing online help (2D code)

Select Help from the SYSTEM menu to show a 2D code.

Scan it with a smartphone to access detailed documents about the product.

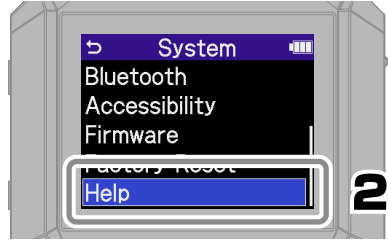
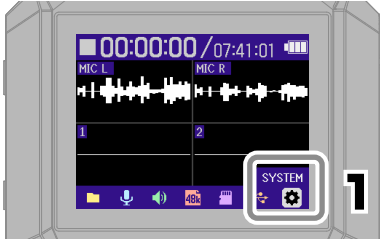

zoomcorp.com/help/h4essential

Functions of parts

■ Top

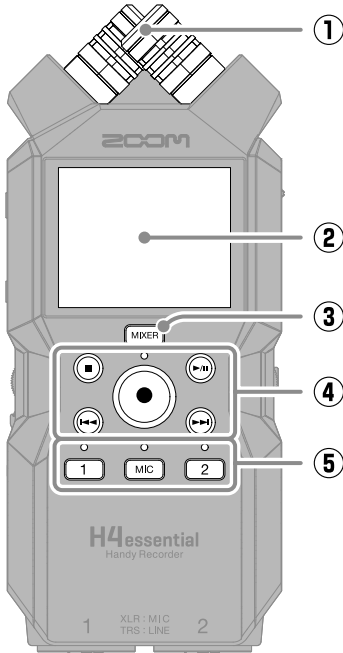

- ① **Built-in XY mic**
This stereo mic has two crossing directional mics. This mic can record three-dimensional sound with natural depth and width.
- ② **Display**
This shows various types of information.
- ③ **MIXER button**
This opens the Mixer Screen.
- ④ **Transport buttons**
STOP button: This stops recording or playback.
PLAY/PAUSE button: This starts/pauses playback of recorded files.
REC button/Indicator: This starts recording. The indicator lights during recording.
REW button: This skips to the previous file. Press and hold this to search backward.
FF button: This skips to the next file. Press and hold to search forward.
- ⑤ **Track buttons/Status indicator**
Press a track button, lighting its status indicator red, to enable that track for recording.

■ Left side

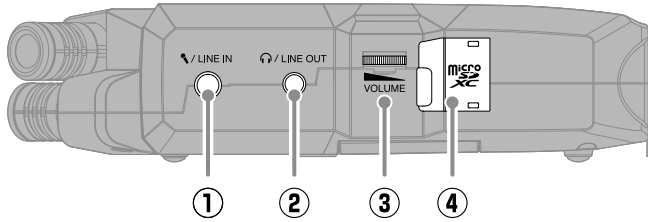

① MIC/LINE IN jack

If an external mic is connected here, it can be used to record instead of the XY mic. This can also provide plug-in power to mics that require it.

② PHONE/LINE OUT jack

This outputs sound to headphones or a connected device.

③ VOLUME dial

Use this to adjust the volume output from the headphones or external device.

④ microSD card slot

Insert a microSD card here.

■ Right side

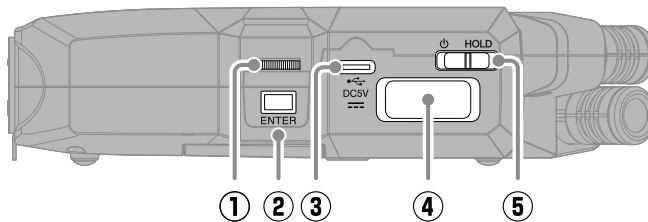

① Select dial

Use this to select menu items.

② ENTER button

Press this to confirm menu items.

③ USB port (Type-C)

Connect this to a computer, smartphone or tablet to use file transfer and audio interface functions.

This supports operation on USB bus power.

Use a USB cable that supports data transfer.

④ REMOTE connector

Connect a ZOOM BTA-1 or other dedicated adapter here.

This enables use of the H4essential Control smartphone/tablet app to operate the H4essential wirelessly.

⑤ POWER/HOLD switch

Use this to turn the power on/off and to disable button operation.

■ Front end

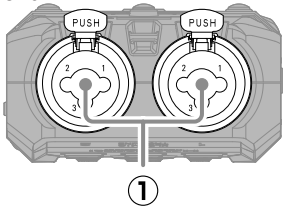

① **INPUT 1, INPUT 2 jacks**

Connect mics and instruments to these. These support XLR and 1/4-inch phone (TRS) plugs.

■ Bottom

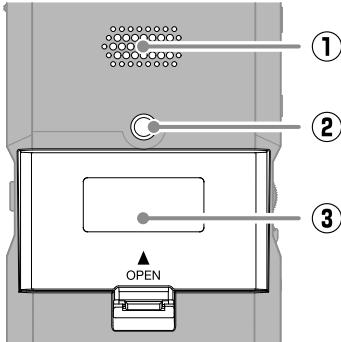

① **Speaker**

Sound is output here during file playback.

② **Tripod mounting threads**

Use these when connecting a tripod.

③ **Battery cover**

Open this when installing and removing AA batteries.

Troubleshooting

Sound is not output or the volume is very low

- Check the headphone and LINE OUT connections.
- Confirm that the headphone volume and line output level are not too low.
- Check the orientation of the mic or the volume settings of the connected equipment.
- Check the mixer settings.

Monitored sound is distorted

- Use  to adjust the volume.

“MIC INPUT OVERLOAD!” or “INPUT 1 (2) OVERLOAD!” appears

- The input sound is too loud. Increase the distance between the mic and the sound source.
- Wind can also cause loud noises to be input. We recommend using the Lo Cut setting to reduce noise if air is blown directly at a mic, for example, when recording outdoors or when a mic is near the mouth of a speaker.

Recording is not possible

- Confirm that the microSD card has open space.
- Confirm that a microSD card is loaded properly in the card slot.

The recorded sound breaks up

- Test the microSD card.
See the Operation Manual for details.
- Use the H4essential to format the microSD card.
- We recommend using microSD cards that have been confirmed to operate with this product.
See the ZOOM website (zoomcorp.com) for information about microSD cards that have been confirmed to work with this unit.

Not recognized by computer when connected

- Use a USB cable that supports data transfer.

Date and time are reset frequently

- If power is not supplied by an AC adapter or batteries for a long time, date and time settings will be reset.
If the Set Date/Time Screen appears during start-up, set them again.

Operation is not possible

- Confirm that  is not set to HOLD.

Product names, registered trademarks and company names in this document are the property of their respective companies. The microSDXC logo is a trademark of SD-3C LLC.

USB Type-C is a trademark of the USB Implementers Forum.

All trademarks and registered trademarks in this document are for identification purposes only and are not intended to infringe on the copyrights of their respective owners.

Recording from copyrighted sources, including CDs, records, tapes, live performances, video works and broadcasts, without permission of the copyright holder for any purpose other than personal use is prohibited by law. ZOOM CORPORATION will not assume any responsibility related to infringements of copyrights.

The illustrations and display screens in this document could differ from the actual product.

ZOOM®

ZOOM CORPORATION

4-4-3 Kanda-surugadai, Chiyoda-ku, Tokyo 101-0062 Japan

zoomcorp.com