

The following features are available in this PDF document.



Quick Keyword Search

Enter the keyword in the search box and hit the search button



Quick Jump between Chapters

Click the title of a specific chapter on the Contents to jump to it

*Reading software such as Adobe Reader is needed to support the functions above.



ZHIYUN FIVERAY F100

User Guide

Contents

■ Brief Introduction	
Brief Introduction	1
■ Get to Know FIVERAY F100	
■ How to Charge	
How to Charge	3
■ Installing Modifiers	
Install and Remove ZHIYUN FIVERAY Stick Light 2-Leaf Barn Doors (hereinafter referred to as “barn doors”)	5
Install and Remove ZHIYUN FIVERAY Stick Light Diffuser (hereinafter referred to as “diffuser”)	7
Install and Remove ZHIYUN FIVERAY Stick Light Grid (hereinafter referred to as “grid”)	9
■ How to Use ZHIYUN FIVERAY F100	
Buttons	12
Brightness/Color Temperature Settings (CCT Mode)	13
Hue (H)/Saturation (S)/Intensity (I) Settings (HSI Mode)	13
FX Light Effect Settings	14
Max Power Settings	14
■ Firmware Upgrade	
■ Product Specifications	
■ Disclaimer and Warnings	
Reading Tips	19
Warnings	19
Safe Operation Guidelines	20

■ Warranty Card

Warranty Period 22

Warranty Exclusions 22

Warranty Claim Procedure 22

■ Contact Card







Brief Introduction

F100 is a high-power portable LED fill light that enables RGB color adjustment and provides supplementary light in multiple scenarios, such as video filming, live interviews, and still-life photography.

F100 has the following features:

1. Slender and portable, easy to use.
2. Adjust brightness/color temperature/hue/saturation freely. Applicable to a wide range of scenarios.
3. High-intensity lighting that satisfies your night-shoot needs.
4. Great color rendering performance to show object colors more naturally.
5. Visible parameters on the screen, convenient for setting.
6. Built-in fans for an effective cooling effect.
7. Various FX light effects are available for more creative lighting.
8. More accessories are available for more control of the lighting.

WARNING

-  This product is not waterproof. Prevent contact with any kind of liquid with the F100. Never use the product in the rain or a humid environment.
-  Do not expose this product to corrosive chemicals, inflammable and explosive materials.
-  Do not touch the heating part when the product is working to avoid getting burned.
-  Do not wrap or block the fans to avoid cooling effect damage.
-  Do not turn the product directly to the eyes to avoid eyesight damage.
-  Do not expose this product to an environment above 40°C .

Get to Know FIVERAY F100

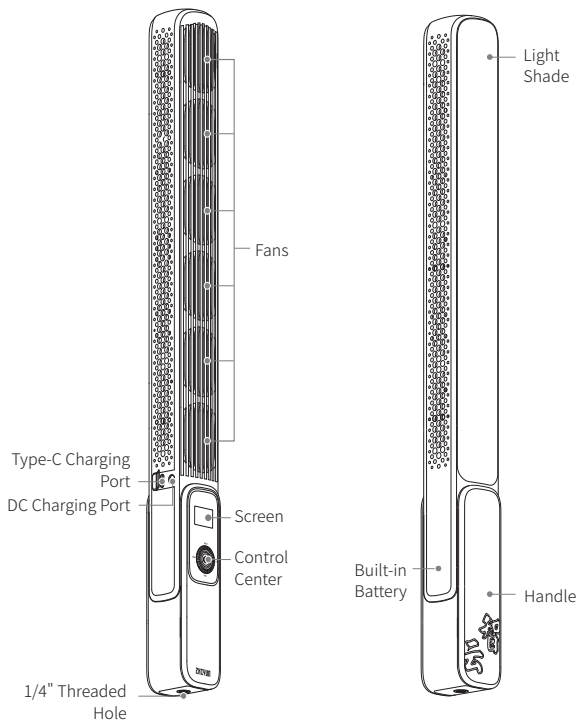

How to Charge

FIVERAY F100 adopts high-capacity built-in lithium battery, providing a solidly long runtime. The battery level is displayed on the screen. The following methods show how to charge your FIVERAY F100 (you can still use the stick light when charging) :

- ① Use a Type-C cable to connect the USB charger to the Type-C port of FIVERAY F100 and plug the USB charger into an AC socket. It is recommended to use USB chargers that meet the PD protocol (support 100W at most). When the USB charger power is 65W or higher, the power will serve as a power supply for the stick light first, and the rest of the power will be charging the battery. When the USB charger power is lower than 65W, the power will just be charging the stick light battery (The battery supports up to 25W charging power).
- ② Connect the TransMount 120W Power Adapter to the DC charging port and an AC socket to charge F100.

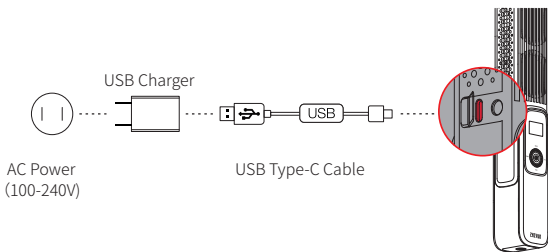

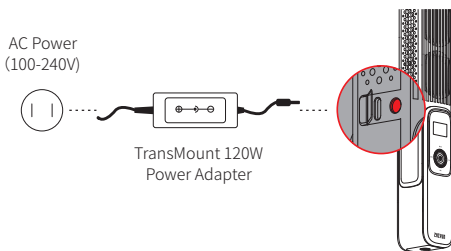

- ① It is recommended to fully charge F100 before using it. Low battery might impair the product performance.
- ② USB chargers and USB cables that support PD fast charging are not included in the package. F100 COMBO offers a TransMount 120W Power Adapter.
- ③ DO NOT use USB charger and TransMount 120W Power Adapter at the same time to charge the F100 to avoid damaging your device.

Install and Remove ZHIYUN FIVERAY Stick Light 2-Leaf Barn Doors (hereinafter referred to as “barn doors”)

Install:

Expand the barn doors to both sides ① . Put the stick light (light shade side up) into the barn doors groove. Make sure the top of the stick light is aligned with the top of the groove. Press to ensure the stick light is engaged in the barn doors groove ② . Adjust the position of the barn doors according to actual use ③ .

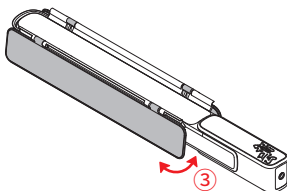
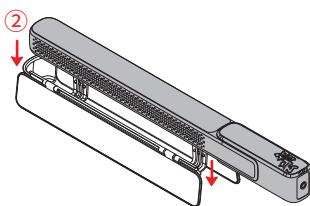
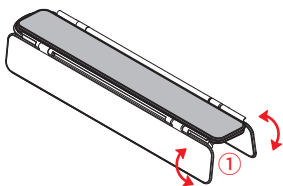

Remove:

Expand the barn doors to the position shown in the figure ① . Separate the upper part of the stick light from the groove with your thumbs as shown in the figure ② , while using other fingers to slide the stick light towards the outer side of the groove ③ . Use the same way to slide the lower part of the stick light out of the groove ④ to remove the barn doors.

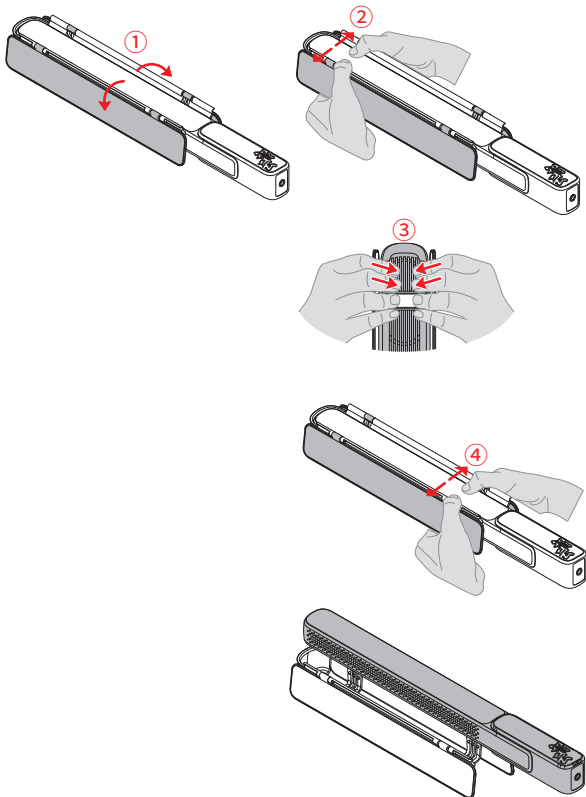

Install and Remove ZHIYUN FIVERAY Stick Light Diffuser (hereinafter referred to as “diffuser”)

Install:

Install the barn doors to the stick light and expand the barn doors to both sides to their vertical state ① . Put the diffuser onto the connection of the barn doors and the groove ② . Push the barn doors outward to put up the diffuser ③ .

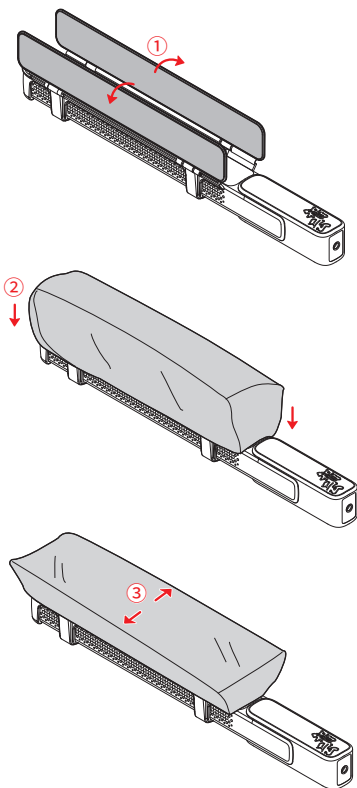

Remove:

Push the barn doors inward until the spacing of two barn doors becomes smaller ① and remove the diffuser from the barn doors ② .

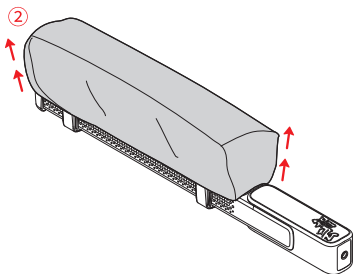
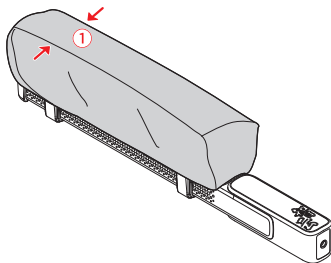

Install and Remove ZHIYUN FIVERAY Stick Light Grid (hereinafter referred to as “grid”)**Install:**

Install the barn doors to the stick light and expand the barn doors to both sides to their vertical state ① . Loosen the straps and make sure both sides of the grid are aligned with the barn doors ② . Push the grid to engage in the barn doors ③ and stick the straps to the other side of the grid.

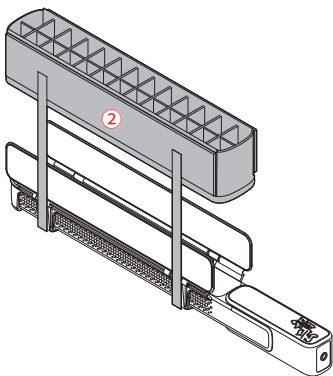
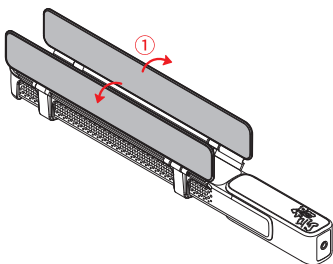

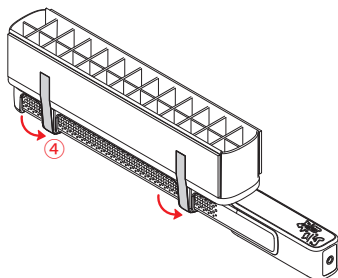
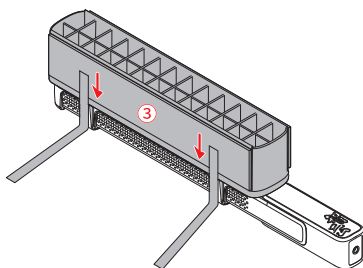

Remove:

Loosen the straps ① and remove the grid from the barn doors ② .

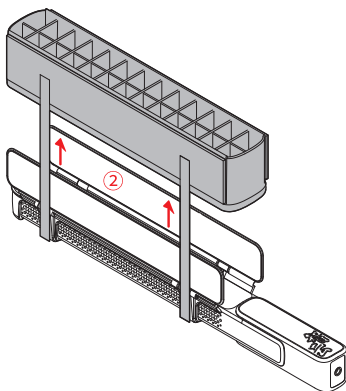
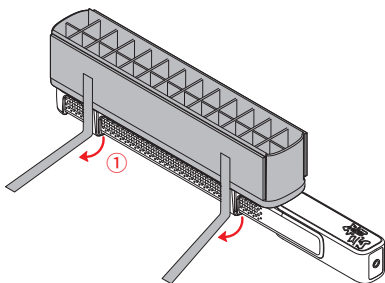

- ⚠ DO NOT stare at the LED chips when the device is operating.
- ⚠ The IP rating of the outer case is IP20.

Buttons

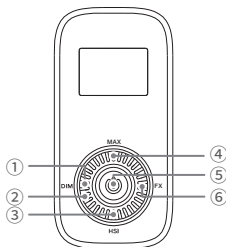

① DIM Mode Button:

Single press:

Enter brightness adjustment interface under CCT mode.

Switch between brightness/color temperature (brightness adjustment interface).

② Dial:

Adjust parameters.

Switch light effect types (light effect interface).

③ HSI Mode Button:

Single press:

Enter HSI Full-color interface.

Switch among Hue (H)/Saturation (S)/Intensity (I) (HSI Full-color interface)

④ Max Power Button:

Single press to enable/disable full power (CCT mode).

⑤ Power/Parameter Switch:

Long press: Power on/off

Double press:

Quick adjustment of brightness/color temperature (CCT mode).

Quick adjustment of Hue (H)/ Saturation (S)/Intensity (I) (HSI mode).

Quick adjustment of brightness (FX Light Effect mode).

⑥ FX Light Effect Mode Button:

Single press:

Enter the light effect adjustment interface under FX Light Effect mode.

Switch between brightness/light effect (light effect adjustment interface).

Brightness/Color Temperature Settings (CCT Mode)

You can adjust brightness/color temperature in CCT mode. Single press DIM Mode Button to enter CCT mode. Double press power/parameter switch for quick adjustment of brightness/color temperature. Rotate the dial to tune the brightness/color temperature value. Please adjust the brightness/color temperature to a proper value according to actual use.

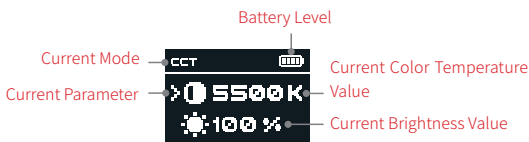

💡 You don't have to change the mode if the stick light is in CCT mode when first powered on or at the last shutdown.

Hue (H)/Saturation (S)/Intensity (I) Settings (HSI Mode)

You can adjust hue/saturation/intensity in HSI mode. Single press HSI Mode Button to enter the mode. Double press power/parameter switch for quick adjustment of hue/saturation/intensity. Rotate the dial to tune the hue/saturation/intensity value. Please adjust the hue/saturation/intensity to a proper value according to actual use.



💡 You don't have to change the mode if the stick light is in HSI mode at the last shutdown.

FX Light Effect Settings

You can adjust the light effect type and brightness in FX Light Effect mode. Single press the FX Light Effect mode button to enter the mode. Select the light effect setting and rotate the dial to select a light effect type. Select the brightness setting and double press power/parameter switch for quick adjustment of brightness. Rotate the dial to tune the brightness value. Please adjust the brightness/light effect type according to actual use.

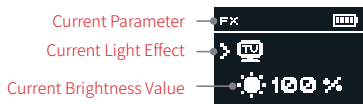

💡 You don't have to change the mode if the stick light is in FX Light Effect mode at the last shutdown.

Max Power Settings

When the stick light is powered on, single press the DIM Mode Button to enter CCT mode, and single press MAX Power Button to enable max power. The stick light will then be in max power output. Double press power/parameter switch for quick adjustment of brightness/color temperature under max power output. Rotate the dial to tune the brightness/color temperature value under max power output. Please adjust the brightness/color temperature to a proper value according to actual use.

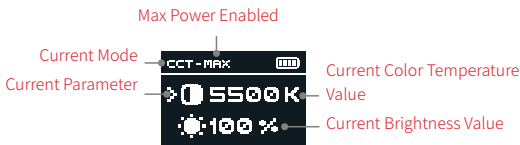

- 💡 ① You don't have to change the mode if the stick light is in CCT mode when first powered on or at the last shutdown.
- ② To properly cool down the stick light, the fans are enabled automatically when the power exceeds a certain level during use.
- ③ To ensure the safety when using the stick light, the overheat protection will be enabled when the temperature is too high.

F100 supports firmware upgrade with “Zhiyun Gimbal Tools”. The following steps show how to upgrade the firmware:

1. Visit the official website of ZHIYUN (www.zhiyun-tech.com), go to the F100 product page, click "Download", find the USB driver, the calibration upgrade tool and the firmware and download. (USB drivers are not required for Mac OS systems)
2. Install the driver, unzip the firmware for the documents with the ".ptz" file extension.
3. Turn off F100.
4. Long press the Max Power button and the Power button at the same time, power on F100 to enter the upgrade mode.
5. Connect the Type-C port of F100 to a computer USB port via a Type-C USB cable.
6. Open "Zhiyun Gimbal Tools", click "Open", click "Firmware Upgrade". Click "Browse" under "Path" to select the latest firmware downloaded (with the ".ptz" file extension), and click "Upgrade" at the bottom to upgrade firmware. F100 will be turned off automatically once the upgrade is successful.

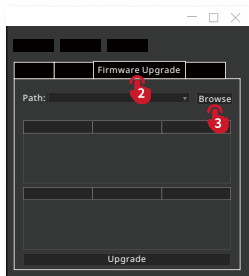
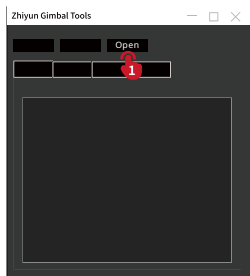
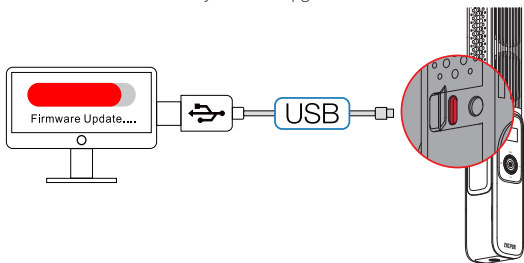

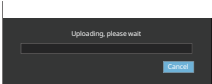
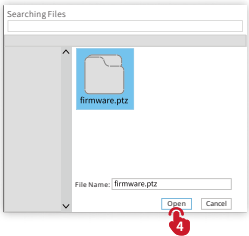

Product Model: PL104

Built-in Battery Capacity	2600MAH Lithium-ion Battery	
Max Power	100W	
Color Temperature Range	2700K~6200K	
Dimming Range	0~100%	
RGB Range	0-360°	
CRI/TLCI	CRI ≥ 96 TLCI ≥ 97	
LED Chip	176 pcs (cool/warm) + 148 pcs (RGB)	
Charging Time (PD)	2H 56min	Lab Data 1
Charging Time (DC)	3H 3min	Lab Data 2
CCT Mode 6200K/100% Illuminance	1200(lux)	Lab Data 3
Max Power Mode 4000K/100% Illuminance	2300(lux)	Lab Data 4
Runtime (Max Power)	31min	Lab Data 5
Operation Temperature	-10°C~ 40°C	
Product Size	502*46*47mm	
Net Weight	950g	
R Illuminance (LUX)	36(lux)	
G Illuminance (LUX)	90(lux)	Lab Data 6
B Illuminance (LUX)	15(lux)	
Power Adapter Output Voltage/Current	24V/5A	

Lab Data 1: When the temperature is 25°C , the charging time is 2h 56 mins via 25W Power Delivery. The actual charging time varies under different conditions: the lower the charging temperature, the lower the charging current, leading to a longer charging time.

Lab Data 2: When the temperature is 25°C , the charging time is 3h 3 mins via 25W -28W Power Delivery. The actual charging time varies under different conditions: the lower the charging temperature, the lower the charging current, leading to a longer charging time.

Lab Data 3: With 25°C temperature, indoor illuminance lower than 0.1lux, and 1m test distance, set the product in CCT mode, 6200K color temperature, 100% brightness, and the illuminance is 1200 lux. The actual illuminance varies under different conditions.

Lab Data 4: With 25°C temperature, indoor illuminance lower than 0.1lux, and 1m test distance, set the product at 4000K color temperature, 100% brightness, and max power, and the illuminance is 2300 lux. The actual illuminance at the max power varies under different conditions.

Lab Data 5: With 25°C temperature and a full battery level, set the product at 4000k color temperature, 100% brightness, and the max power, and the battery runtime is 31 mins. The actual battery runtime varies under different conditions: the longer the operating time, the higher the charge and discharge frequency, and the less battery activity, leading to a shorter battery runtime.

Lab Data 6: With 25°C temperature, indoor illuminance lower than 0.1lux, and 1m test distance, set the product at 100% saturation and 100% brightness, and the red/green/blue illuminance is 36lux/90lux/15lux. The actual red/green/blue illuminance varies under different conditions.

The above data is gathered from internal experiments of ZHIYUN laboratories. Under different scenarios, data is different to some extent. Please refer to the actual use.

Thank you for purchasing FIVERAY F100. The information contains herein affects your safety, legitimate rights and obligation. Please read this instruction carefully to ensure proper configuration before use. Failure to read and follow this instruction and warnings herein may result in serious injury to you or bystanders, or damage to your device or property. Guilin Zhishen Information Technology Co., Ltd (hereinafter referred to as "ZHIYUN") reserves all rights for final explanation of this instruction and other documents related to FIVERAY F100. The information is subject to update without notice. Please visit www.zhiyun-tech.com to obtain the latest product information.

By using this product, you hereby signify that you have read this document carefully and that you understand and agree to abide by the terms and conditions herein. You agree that you are solely responsible for your own conduct while using this product, and for any consequences thereof. You agree to use this product only for purposes that are proper and in accordance with all terms, precautions, practices, policies and guidelines ZHIYUN has made and may make available.

ZHIYUN accepts no liability for damage, injury or any legal responsibility incurred directly or indirectly from the use of this product. Users shall observe safe and lawful practices including, but not limited to, those set forth herein.

ZHIYUN™ is the trademark of Guilin Zhishen Information Technology Co., Ltd and its affiliates. All product names or trademarks referred to herein are trademarks or registered trademarks of their respective holders.

Reading Tips

Legends:  Hints and Tips

 Important

Warnings

Read the ENTIRE User Guide to become familiar with the features of this product before operating. Failure to operate the product correctly can result in damage to the product or personal property and cause serious injury.

This is a sophisticated product. It must be operated with caution and common sense and requires some basic mechanical ability. Failure to operate this product in a safe and responsible manner could result in injury or damage to the product or other property. This product is not intended for use by children without direct adult supervision.

DO NOT use with incompatible components or in any way otherwise as mentioned or instructed in the product documents provided by ZHIYUN. The safety guidelines herein contain instructions for safety, operation and maintenance. It is essential to read and follow all of the instructions and warnings in the User Guide, prior to assembly, setup or use, in order to operate the product correctly and avoid damage or serious injury.

Safe Operation Guidelines

1. This product is a high-precision control device. Damage may be caused to FIVERAY F100 if dropped or subject to external force, and this may result in malfunction.
 2. It is recommended to keep your hands dry while using FIVERAY F100 and use dry cloth for cleaning.
 3. Keep this product out of the reach of children.
 4. Protect FIVERAY F100 from dust and sand during use.
 5. Do not disassemble this product personally. In the event of malfunctions, it should be repaired by ZHIYUN's or other authorized maintenance personnel.
- WARNING: To avoid fire, serious injury, and property damage, observe the following safety guidelines when using, charging, or storing your batteries.**
1. Prevent the batteries from coming into contact with any kind of liquid. Do not leave batteries out in the rain or near a source of moisture. Do not drop the battery into water. If the inside of the battery comes into contact with water, chemical decomposition may occur, potentially resulting in the battery catching on fire, and may even leading to an explosion.
 2. If the battery catches fire, use sand or dry powder fire extinguisher immediately to put out the fire.
 3. Never use non-ZHIYUN batteries. If replacement or backup is needed, please purchase new batteries from ZHIYUN's official website or authorized channels. ZHIYUN takes no responsibility for any damage caused by non-ZHIYUN batteries.
 4. Never use or charge swollen, leaky, or damaged batteries. Never use or charge if the battery smells, or overheats (exceeding the maximum temperature of 160° F/71° C). If your batteries are abnormal, contact ZHIYUN or a ZHIYUN authorized dealer for further assistance.
 5. The battery should be used within the temperature range from -10° C to 45° C. Use of battery in environments above 45° C may lead to a fire or explosion. Use of battery below -10° C may lead to serious battery damage.
 6. Do not use the battery in strong electrostatic or electromagnetic environments. Otherwise, the battery protection board may malfunction.
 7. Do not disassemble or use any sharp object to puncture the battery in any way. Otherwise, the battery may leak, catch fire or explode.

8. Do not mechanically strike, crush, or throw the battery. Do not place heavy objects on the battery or charger.
9. Electrolytes inside the battery are highly corrosive. In case of accidental contact of any electrolytes with your skin or eyes, rinse immediately with water for at least 15 minutes and seek medical advice as soon as possible.
10. Do not use the battery if it has been involved in a crash or heavy impact.
11. Do not heat the battery and never put the battery in a microwave oven or in a pressurized container.
12. Do not place the battery on a conductive surface (such as a metal desk surface, eyeglasses, watch, jewelry, etc.)
13. Prevent use of wires or other metal objects that could cause positive and negative short-circuit to the battery.

Battery Charging:

1. Do not put the battery and charger near flammable materials or on flammable surfaces (such as carpet or wood). Never leave the battery unattended during charging to prevent any accidents.
2. Please disconnect the battery and the charger when fully charged.
3. Do not charge the battery immediately after use, because the battery temperature may be too high. Do not charge the battery until it cools down to normal room temperature. Charging the battery with its temperature over 45° C or lower than 0° C may lead to leakage, overheating, or damage.

Battery Storage:

1. Keep batteries out of the reach of children and pets.
2. Do not leave the battery near heat sources such as a furnace or heater, or inside of a vehicle on hot days. Never expose the battery in any environment with temperature of over 60° C. The ideal storage temperature is 22° C-28° C.
3. Store batteries in a dry environment.
4. Do not leave the battery unused for too long after it has been completely discharged to prevent over-discharge of battery which may result in battery damage and permanent failure.

Battery Maintenance:

1. Do not over-charge or over-discharge the battery, which will damage the battery;
2. The battery performance will be affected for not being used for a long time;
3. Never store the battery in any environment with temperature of over 60° C;
4. Recharge and discharge every 3 months to keep the battery active.

Battery Disposal:

Please fully discharge the battery before putting it in the designated recycling bin. Batteries contain hazardous constituents and it is forbidden to put the battery in general waste bin. For related details please abide by the local laws and regulations on battery recycling and disposal.

Warranty Period

1. Customers are entitled to replacement or free repair service in case of quality deficits found in the product within 15 days upon receipt of the product.
2. Customers are entitled to free repair service from ZHIYUN for any product proven defective in material or workmanship that results in product failure during normal consumer usage and conditions within the valid warranty period, which is 12 months counting from the date of selling. However, warranty period varies by product component and country of purchase. Please contact our after-sales service team on ZHIYUN official website or your place of purchase for detailed warranty information.

Warranty Exclusions

1. Products subjected to unauthorized repair, misuse, collision, neglect, mishandling, soaking, accident, and unauthorized alteration.
2. Products subjected to improper use or whose labels or security tags have been torn off or altered.
3. Products whose warranty has expired.
4. Products damaged due to force majeure, such as fire, flood, lightning, etc.

Warranty Claim Procedure

1. If failure or any problem occurs to your product after purchase, please contact a local agent for assistance, or you can always contact ZHIYUN's customer service through email at info@zhiyun-tech.com or website at www.zhiyun-tech.com.
2. Your local agent or ZHIYUN's customer service will guide you through the whole service procedure regarding any product issue or problem you have encountered. ZHIYUN reserves the right to reexamine damaged or returned products.

Customer Information

Customer Name:

Phone Number:

Address:

Sales Information

Sales date:

Product Serial Number:

Distributor Name:

Distributor's Contact Number:

First Maintenance Record

Service Date:

Repairman Signature:

Cause of Problem:

Service Result:

Solved

Unsolved

Refunded/Replaced



Website



Weibo



Vimeo



Google+



Facebook
(Zhiyun Support)



Facebook
(Zhiyun Tech)



Youku



Youtube



Wechat



Instagram

Tel: +86 400 900 6868

USA Hotline: +1 808-319-6137,9:00-18:00 GMT-7,Mon-Fri

Europe Hotline: +49 (0) 61018132180,10:00-17:00 GMT+1,Mon-Fri

Web: www.zhiyun-tech.com

E-mail: info@zhiyun-tech.com

Address: 09 Huangtong Road, Tieshan Industrial Zone, Qixing District, Guilin, 541004, Guangxi, China

Certificate of Quality

This product is confirmed to meet quality standards and permitted for sale after strict inspection.

QC Inspector: _____



For full product information, please visit ZHIYUN's official website: Content on www.zhiyun-tech.com is subject to update without notice.

ZHIYUN™ is a trademark of ZHISHEN

All product names or brands referred to hereunder may be trademarks or registered trademarks of their respective holders.

Copyright © 2022 ZHISHEN. All rights reserved.

ZHIYUN-TECH.COM