

# F2/F2-BT

## Field Recorder

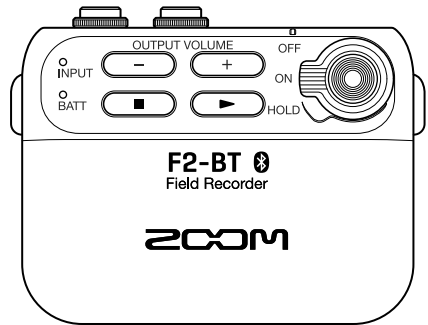
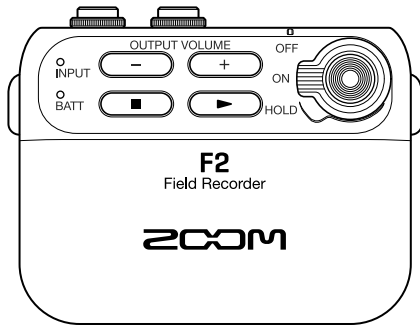

## Operation Manual

You must read the Usage and Safety Precautions before use.



The Operation Manual can be downloaded from the ZOOM website ([www.zoom.jp/docs/f2\\_f2-bt](http://www.zoom.jp/docs/f2_f2-bt)).

This page has files in PDF and ePub formats.

The PDF file format is suitable for printing on paper and reading on a computer.

The ePub format can be read with electronic document readers and is designed for reading on smartphones and tablets.

© 2021 ZOOM CORPORATION

Copying or reprinting this manual in part or in whole without permission is prohibited.

Product names, registered trademarks and company names in this document are the property of their respective companies.

All trademarks and registered trademarks in this document are for identification purposes only and are not intended to infringe on the copyrights of their respective owners.

You might need this manual in the future. Always keep it in a place where you can access it easily.

The contents of this manual and the specifications of the product could be changed without notice.

# Contents

F2/F2-BT features.....	3
Use examples .....	3
Functions of parts .....	4
Preparing for use .....	5
Turning the power on.....	6
Connecting the lavalier mic.....	6
Recording .....	7
Playing recordings .....	7
Transferring files to computers .....	8
Using a computer to change settings .....	9
Connecting to a smartphone/tablet and using F2 Control for remote control (F2-BT only) .....	9
List of F2 Editor/F2 Control functions .....	10
Troubleshooting .....	11

## F2/F2-BT features

With a dual A/D converter circuit and support for 32-bit float WAV files, recording with the highest audio quality is possible.

### ■ Dual A/D converter circuit

The input circuit has two A/D converters with different input gains. Recording with high audio quality is possible without adjusting the gain whether the input sound is loud or quiet.

### ■ 32-bit float WAV files

Recording with 32-bit float WAV file formats allows audio quality to be restored when editing.

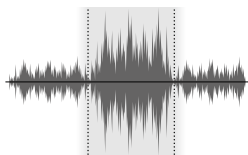

- Wide dynamic range
- Recording level always optimal

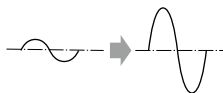

- High resolution even for quiet sounds

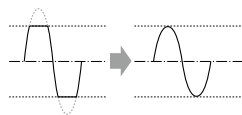

- Waveforms can be restored to unclipped states

## Use examples

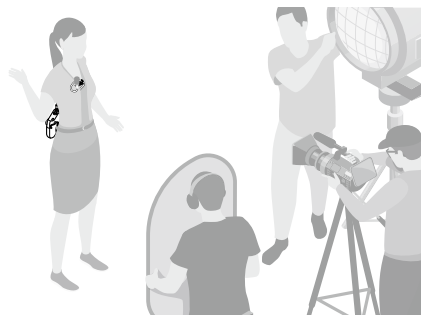

Since input gain adjustment is unnecessary, recording can be started by pressing a single button after putting the mic on.

# Functions of parts

## ■ Front

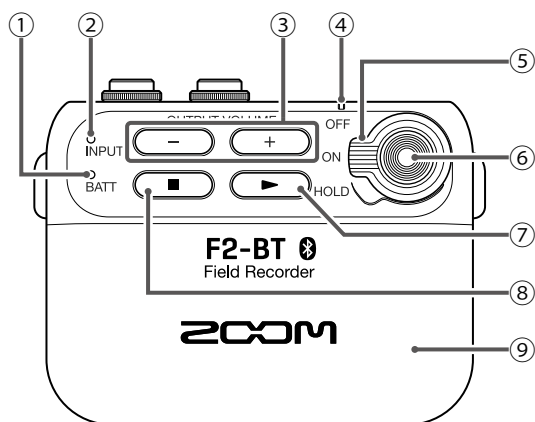

- ① **BATT LED**  
The color of the light changes according to the remaining battery charge.
- ② **INPUT LED**  
This lights according to the input level through the INPUT jack.
- ③ **OUTPUT VOLUME -/+ buttons**  
Use these to adjust the output volume. Raising the volume too much could cause the monitored sound to become distorted, but the recorded data will not be distorted.
- ④ **REC/PLAY LED**  
This lights during recording and playback.
- ⑤ **Power switch**  
Use this to turn the power ON/OFF and to disable button operation.
- ⑥ **REC button**  
Use this to start/stop recording.
- ⑦ **Play button**  
Use to play recorded files.
- ⑧ **Stop button**  
Press to stop playback of recorded files.
- ⑨ **Battery compartment cover**  
Remove when installing or removing batteries.

## ■ Back

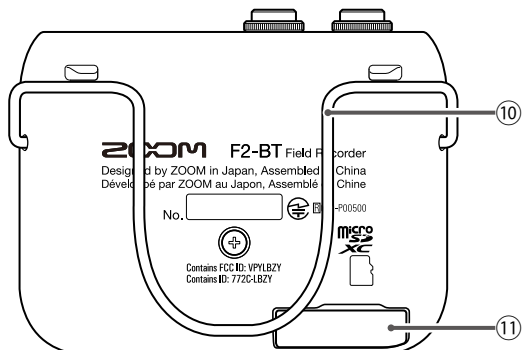

- ⑩ **Belt clip**
- ⑪ **microSD card slot**  
Insert a microSD card here.

## ■ Top

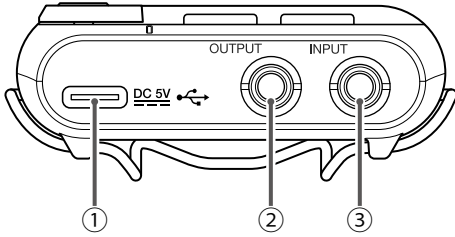

### ① DC 5V (USB Type-C) connector

- A dedicated AC adapter (ZOOM AD-17) can also be connected here to use AC power.
- This can also be connected to a computer for use. Files can be moved, and F2/F2-BT settings can be made using the F2 Editor app.

### ② OUTPUT jack

Connect headphones, for example, here.

### ③ INPUT jack

Connect a lavalier mic here.

## Preparing for use

In order to use an F2/F2-BT, an application must be installed on a computer and initial settings for it must be made. See [page 9](#) for details about installing the application.

### ■ Turn the power on

After turning the power off, open the battery compartment cover and install batteries. When the power is on, the remaining battery charge can be checked with the BATT LED.

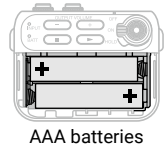
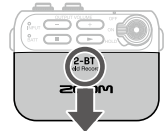

AAA batteries

BATT LED	Remaining battery charge
Lit green	Full
Lit orange	↕
Blinking orange	↕
Blinking red	Empty

### HINT

An AD-17 AC adapter can also be used.

### NOTE

- Use only one type of batteries (alkaline, NiMH or lithium) at a time.
- If the BATT LED does not light after the power is turned on, set the power to OFF and install new batteries.
- After installing the batteries, set the battery type correctly. Use F2 Editor or F2 Control (F2-BT only) to set this.

## ■ Insert a microSD card

After turning the power off, open the microSD card slot cover and insert a card.

To remove a microSD card, push it further into the slot and then pull it out.

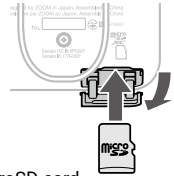



microSD card

### NOTE

- Always make certain that the power is off when inserting or removing a microSD card. Inserting or removing a card while the power is on could result in data loss.
- When inserting a microSD card, be sure to insert the correct end with the top side up as shown.
- Recording and playback are not possible when a microSD card is not loaded.
- Use F2 Editor to format microSD cards.

## Turning the power on

1. Set  to ON.
2. To turn the power off, set  to OFF.

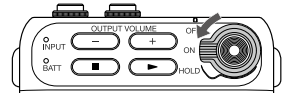

### HINT

Setting  to HOLD will disable button operations.

## Connecting the lavalier mic

1. Attach the windscreen and the clip to the lavalier mic.
2. Connect the lavalier mic to the INPUT jack, and tighten the screw lock.

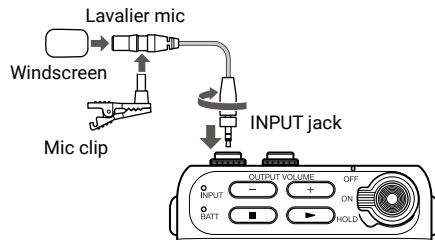
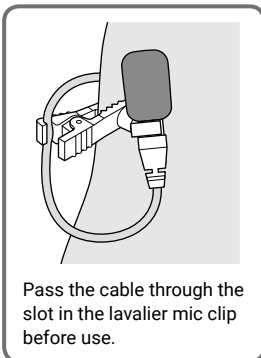

## HINT

- Mics without screw locks can also be connected.
- The INPUT LED lights green according to the input level. If the input level is too high, it will blink red.

## NOTE

- The INPUT jack always supplies plug-in power (2.5 V).
- Check the power specifications before using a mic made by a different company.
- Do not connect a device that does not support plug-in power.

## Recording

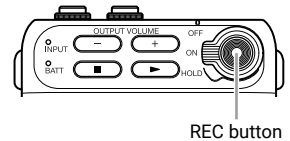

1. Press .
2. Press  again to stop recording.



## NOTE

During recording, the REC/PLAY LED lights red.

## Playing recordings

1. Connect headphones, for example, to the OUTPUT jack.
2. Press .
3. Press  to stop playback.

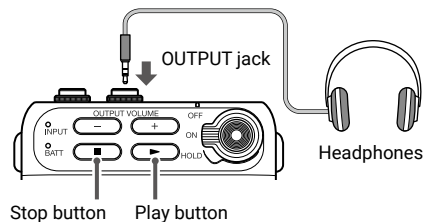

## HINT

- Use   to adjust the output volume.
- During playback, the REC/PLAY LED lights green.

# Transferring files to computers

1. Turn the F2/F2-BT power on.
2. Use a USB cable to connect the F2/F2-BT and the computer.

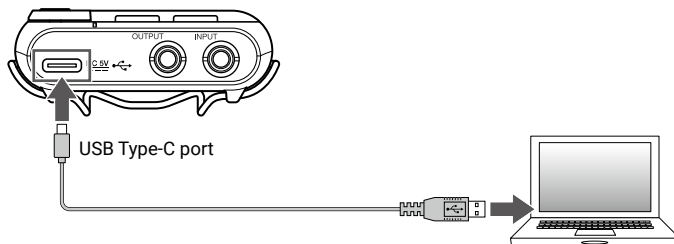

3. Use the computer to transfer the necessary files.
4. When you want to disconnect, use the computer to end the USB connection with the F2/F2-BT.

## ■ F2/F2-BT folder and file structure

When recording with an F2/F2-BT, folders and files are created on microSD cards in the following manner.

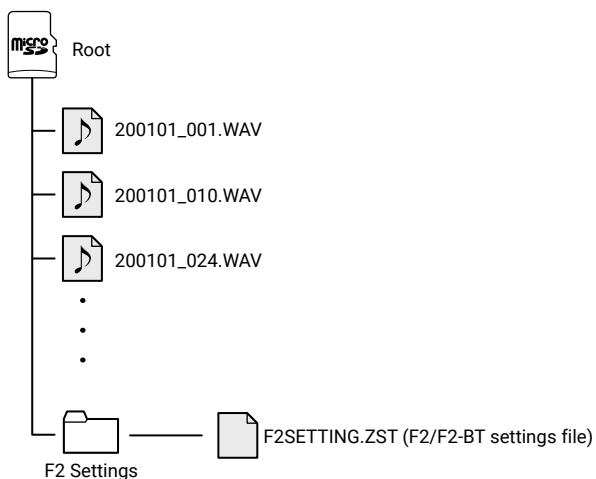



## Using a computer to change settings

1. **Install F2 Editor on the computer.**  
This can be downloaded from the ZOOM website (zoomcorp.com).
2. **Turn the F2/F2-BT power on.**
3. **Use a USB cable to connect the F2/F2-BT and the computer.**

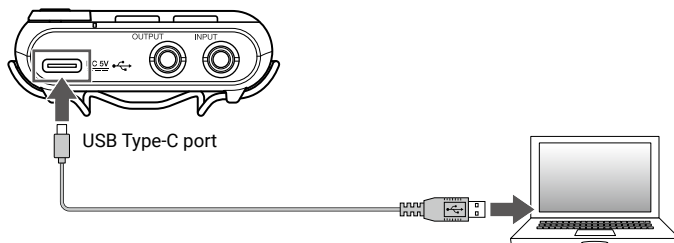

4. **Launch F2 Editor, and change the F2/F2-BT settings.**

### NOTE

Connection with a computer is not possible during recording or playback.

## Connecting to a smartphone/tablet and using F2 Control for remote control (F2-BT only)

1. **Install the F2 Control app from the App Store or Google Play on the smartphone/tablet.**
2. **Turn the F2-BT power on.**
3. **Launch F2 Control on the smartphone/tablet.**  
When F2 Control launches, a Bluetooth device list will appear. Tap the device name/ID to connect to the F2-BT.  
The REC/PLAY LED will light orange on the F2-BT connected to F2 Control.
4. **Use F2 Control to operate and set the F2-BT.**

### NOTE

Connection with F2 Control is not possible when connected to a computer.

## List of F2 Editor/F2 Control functions

Function	Explanation	F2 Editor	F2 Control
Record/play/stop	Control record, play, stop and other operations		✓
Remaining battery charge display	Check remaining battery charge		✓
Recording/playback file name display	Check name of file being recorded/played		✓
Elapsed recording time display	Check elapsed recording time		✓
Recordable time display	Check remaining recordable time		✓
Level meter display	Check input level (level meter)		✓
Error message display	Check error content		✓
Lo Cut	Set low-cut function	✓	✓
Output Volume	Adjust output volume	✓	✓
Rec Format	Select recording format	✓	✓
Rec File Name	Set recording file name	✓	✓
User Defined Name	Edit text used for file name	✓	✓
Rec File Note	Edit note for recording file		✓
Date/Time	Set date and time added to recording files	✓	✓
Battery Type	Select type of battery	✓	✓
Bluetooth Function	Select function to use by Bluetooth	✓	
Forget Device	End pairing with timecode synchronization device	✓	
Auto Power Off	Set time until power turns off automatically	✓	✓
Factory Reset	Reset to factory default settings	✓	
SD Card Format	Format microSD card for use	✓	
Finder	Check files on microSD card		✓
Rename	Change names of recorded files		✓
Note	Edit notes of recorded files		✓
Version	Check version	✓	✓

# Troubleshooting

## ■ Recording and playback

### Recording is not possible

---

Confirm that the REC/PLAY LED is lit red.

Confirm that the microSD card has open space.

If the HOLD function is on, button operations will be disabled. Disable the HOLD function.

### Recorded sound cannot be heard or is very quiet

---

Confirm that the REC/PLAY LED is lit green during playback.

### There is no sound or output is very quiet

---

Confirm that the REC/PLAY LED is lit green during playback.

Check the connections to the monitoring system and its volume setting.

Confirm that the volume of the F2/F2-BT is not too low.

## ■ Other issues

### The unit is not recognized by a computer connected using a USB cable

---

Confirm that the operating system is compatible.

### Cannot connect with a Bluetooth device

---

Use F2 Editor to check the Bluetooth function setting.

### Battery operation time is short

---

Making the following settings could increase the battery operation time.

- Use F2 Editor to set the power supply used correctly.
- Disconnect any unneeded plug from the OUTPUT jack, for example.

iPadOS is a trademark or registered trademark of Apple Inc.

App Store is a service mark of Apple Inc.

iOS is a trademark or registered trademark of Cisco Systems, Inc. in the USA and other countries and is used under license.

Android and Google Play are trademarks of Google LLC.

The Bluetooth® word mark and logo are registered trademarks of Bluetooth SIG, Inc., and these marks are used under license by Zoom Corporation. Other trademarks and trade names are the property of their respective companies.

Recording from copyrighted sources, including CDs, records, tapes, live performances, video works and broadcasts, without permission of the copyright holder for any purpose other than personal use is prohibited by law. Zoom Corporation will not assume any responsibility related to infringements of copyrights.



**ZOOM CORPORATION**

4-4-3 Kanda-surugadai, Chiyoda-ku, Tokyo 101-0062 Japan  
[zoomcorp.com](http://zoomcorp.com)