

NANLITE

Forza 150
USER MANUAL

Guangdong NanGuang Photo&Video Systems Co., Ltd

Forza 150 LED Spot Light

■ Product Diagram

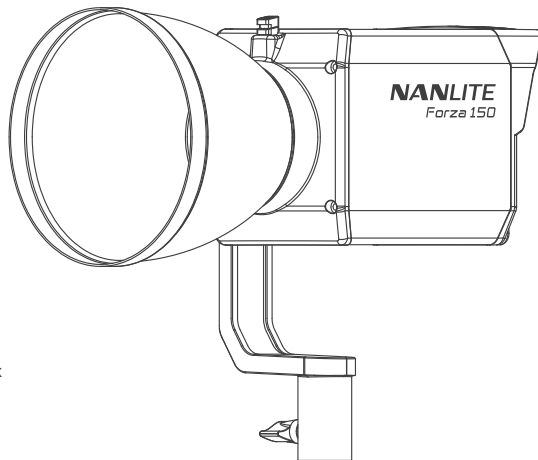

■ Technical Data

Rated Power: 170W

Input voltage/current: DC24V/7.5A Max
AC100-240V 50/60Hz

CRI: 96

TLCI: 98

This user manual applies for both 5600K and 3200K color temperature LED fixture.

Product Details

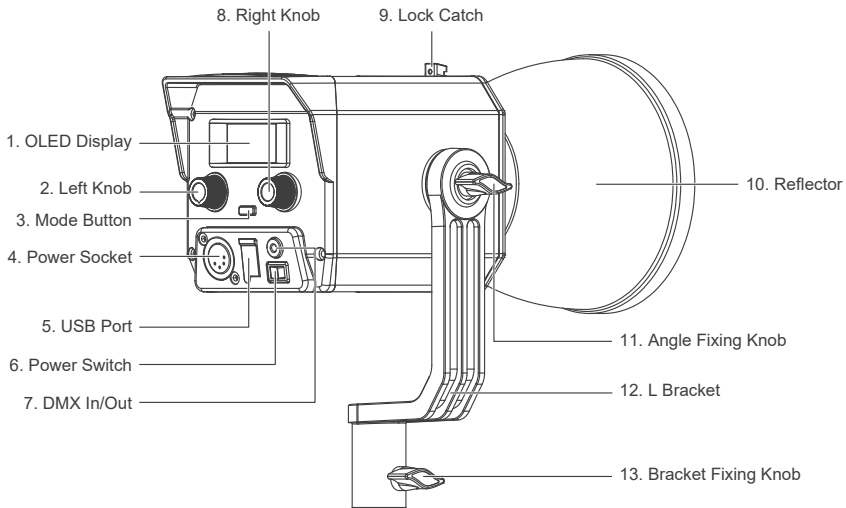

Detailed Description

1. OLED Display: Display functions and lighting parameters.
2. Left Knob: Use to adjust dimming and set different parameters.
3. MODE Button: Use to switch between DAYLIGHT, EFFECT and MENU.
4. Power Socket: Connect DC power to the fixture.
5. USB Port: Use to update firmwares.
6. Power Switch: Switch on/off the fixture.
7. DMX In/Out: Use to plug in a DMX adapter cable for DMX signal in/out.
(Note: DMX adapter cable is sold separately).
8. Right Knob: Use to select various functions.
9. Lock Catch: Use to mount and dismount the reflector and other accessories.
10. Reflector: Converge rays of light to improve central illumination.
11. Angle Fixing knob: Tilt the fixture to different angles.
12. L Bracket: Connect the fixture on light stand.
13. Bracket Fixing knob: Fix the fixture on the yoke and pan it to different angles.

Installation

1. Mount and dismount the reflector as shown

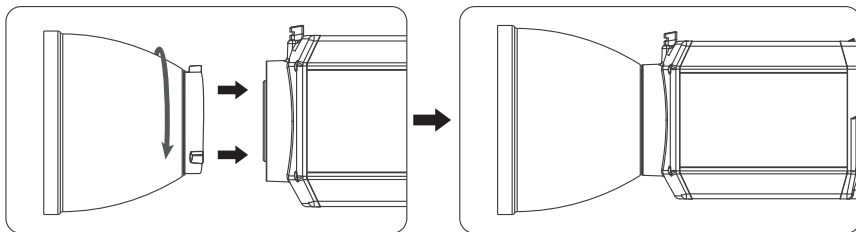

① Align the reflector with the mount and rotate according to the sign to secure it onto the fixture.

Note: The fixture is compatible with accessories with FM mount, Bowens adapter need to be added for accessories with Bowens mount.

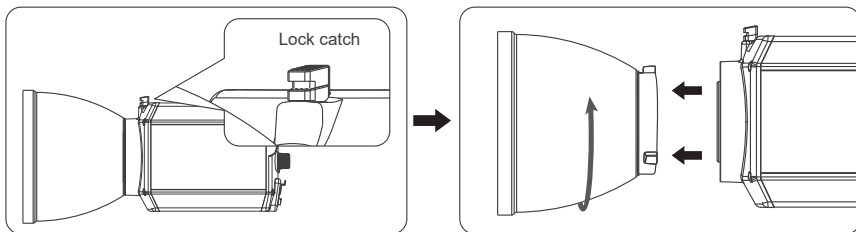

② Press the lock catch and rotate the reflector according to the sign to release it from the fixture.

2. Mount and dismount the Bowens adapter as shown

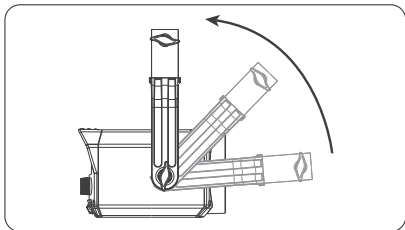

① Adjust the L bracket to the overhead position first.

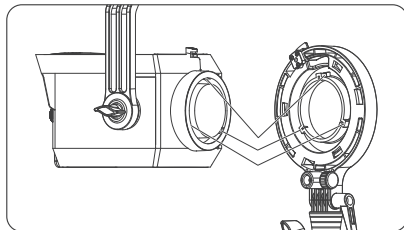

② Insert the adapter after aligning it with the mount and rotate according to the sign to secure it into place.

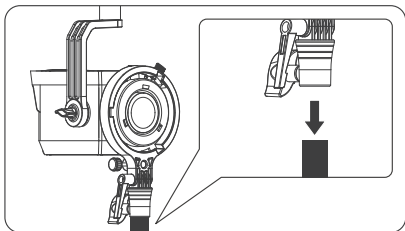

③ Mount the adapter on the light stand.

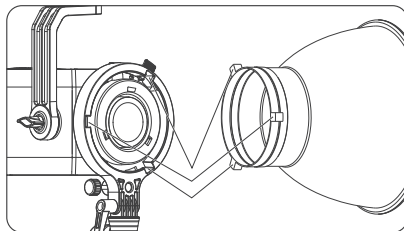

④ Align the accessory with Bowens mount with the adapter and rotate according to the sign to secure it into place.

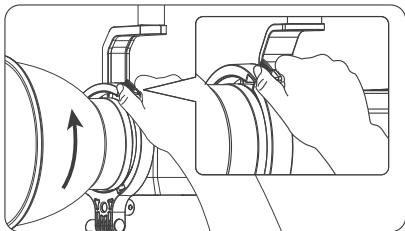

⑤ Press the lock catch on the adapter and rotate according to the sign to release the accessory from the adapter.

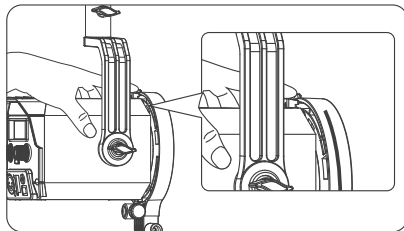

⑥ Press the lock catch on the fixture and rotate according to the sign to release the adapter from the fixture.

Remote Control

· Forza 150 supports DMX, RDM, 2.4G remote control, and includes a built-in Bluetooth as well.

▲ CH needs to be pre-set for DMX, RDM and 2.4G remote control solutions.

1. CH and DMX Mode Setting

① CH Setting



Press "MODE" button to select "MENU".

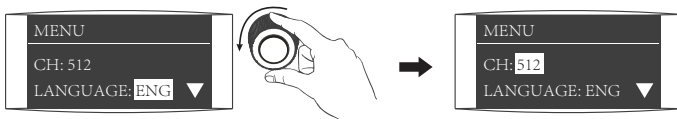

Rotate right knob to select "CH".



Rotate left knob to select desired address code.

②DMX Mode setting



Press "MODE" to select "MENU".



Rotate right knob to select "DMX MODE".



Rotate left knob to select desired DMX Mode ("DAYLIGHT" or "ULTIMATE").

2. DMX Remote Control

① Connect the fixture to the DMX/RDM consoles via DMX adapter cable as shown below:



②DMX Terminator

In DMX control mode, the DMX output of the last fixture should be connected with a DMX terminator (Not included). This prevents interference caused by DMX signals in the transmitting process.

The terminator is connected with a 120Ω resistor across Pin 2 and Pin 3. (As shown below)

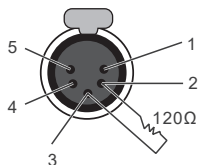

DMX Terminator Connection
Connect a 120Ω resistor across
Pin 2 and Pin 3 in an XLR plug
and insert into the DMX OUT
socket on the last fixture.

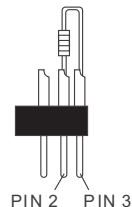

③Set the channel of the fixture.

④Control the fixtures via DMX/RDM console by referring to the DMX reference guide (Also refer to DMX/RDM console user manual for detailed operation).

Note: DMX reference guide "Forza 150_REFERENCE_GUIDE_EN" is downloadable by logging on www.nanlite.com or scanning the QR code below.



Please scan the QR code to check or download the latest DMX reference guide.

3. RDM Remote Control

- ① Connect the fixture to the console with RDM function via DMX adapter cable.
- ② Control the fixture via the console (Please refer to console user manual for detailed operation).

Note: fixture's UID format is as below shown:

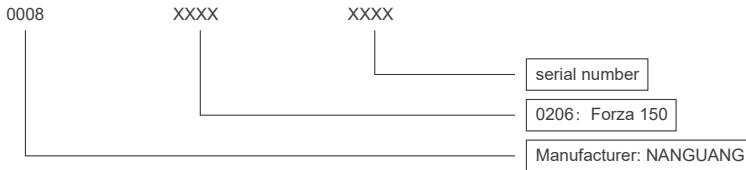

4. 2.4G remote control

- Set the address of the 2.4G remote controller to be consistent with the light fixture, enabling the Forza 150 to be remotely controlled by 2.4G remote controller or by APP via the transmitter box.

Note: ① 2.4G remote controller and transmitter box are sold separately.

- ② The fixture supports the 2.4G wireless protocol V1.0 and V2.0. Set fixture to V2.0 while using WS-RC-C1 or WS-RC-C2 remote controller. Set fixture to V1.0 while using other remote controllers.



Press "MODE" to select "MENU".



Rotate the right knob to select "WIRELESS PROTOCOL".



Rotate the left knob to select V1.0 or V2.0.

Operating Instructions

1. Connection (as shown)

① Switch on the fixture, the display shows the current settings.

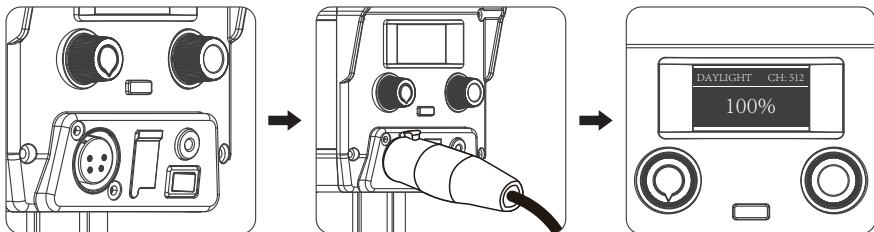

②DAYLIGHT Mode Setting: Press "MODE" button to select "DAYLIGHT", rotate the left knob clockwise to increase brightness, rotate anti-clockwise to decrease brightness, dimming percentage is shown within the range of 000% to 100%.



Press "MODE" button to select "DAYLIGHT".

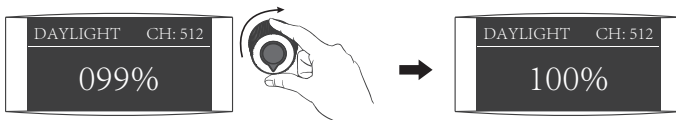

Rotate the right knob clockwise to increase brightness.



Rotate the right knob anti-clockwise to decrease brightness.

③EFFECT Setting:

Forza 150 includes 11 built-in effects: INT LOOP, FLASH, PULSE, STORM, TV, PAPARAZZI, CANDLE/FIRE, BAD BULB, FIREWORK, EXPLOSION and WELDING.



Press "MODE" to select "EFFECT".

(1)INT LOOP

INT LOOP setting: rotate the right knob to select "DIM" or "SPD" (Range: 2s-30s), then rotate the left knob to set the parameter under the corresponding selection.



Rotate the right knob to select the "DIM" or "SPD".



Rotate the left knob to set the parameter under the corresponding selection.

(2)FLASH

FLASH setting: rotate the right knob to select "DIM" or "INTVL" (Range: 0.1s-10.0s), then rotate the left knob to set the parameter under the corresponding selection.



Rotate the right knob to select the "DIM" or "INTVL".



Rotate the left knob to set the parameter under the corresponding selection.

(3)PULSE

PULSE setting: rotate the right knob to select "DIM" or "PULSES/M" (Range: 1-240), then rotate the left knob to set the parameter under the corresponding selection.



Rotate the right knob to select the "DIM" or "PULSES/M".



Rotate the left knob to set the parameter under the corresponding selection.

(4)STORM

STORM setting: rotate the right knob to select "DIM" or "INTVL" (Range: 1s -60s) , then rotate the left knob to set the parameter under the corresponding selection.



Rotate the right knob to select the "DIM" or "INTVL" .



Rotate the left knob to set the parameter under the corresponding selection.

(5)TV

TV setting: rotate the right knob to select "DIM" or "SPD" (Range: 1-100), then rotate the left knob to set the parameter under the corresponding selection.

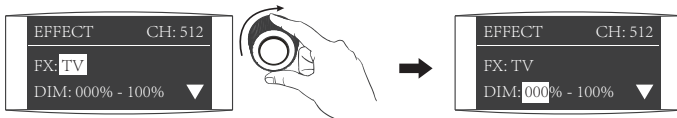

Rotate the right knob to select the "DIM" or "SPD".

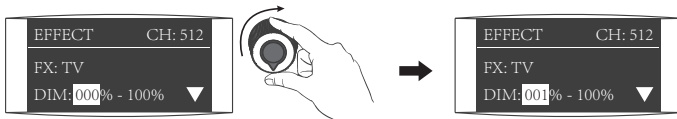

Rotate the left knob to set the parameter under the corresponding selection.

(6)PAPARAZZI

PAPARAZZI setting: rotate the right knob to select "DIM" or "SPD" (Range: 1-100), then rotate the left knob to set the parameter under the corresponding selection.



Rotate the right knob to select the "DIM" or "SPD".



Rotate the left knob to set the parameter under the corresponding selection.

(7)CANDLE/FIRE

CANDLE/FIRE setting: rotate the right knob to select "DIM" or "SPD" (Range: 1-100), then rotate the left knob to set the parameter under the corresponding selection.

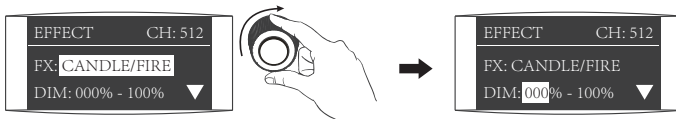

Rotate the right knob to select the "DIM" or "SPD".



Rotate the left knob to set the parameter under the corresponding selection.

(8)BAD BULB

BAD BULB setting: rotate the right knob to select "DIM", "INTENSITY" (Range: 1-100) or "SPD" (Range: 1-100), then rotate the left knob to set the parameter under the corresponding selection.



Rotate the right knob to select the "DIM", "INTENSITY" or "SPD".



Rotate the left knob to set the parameter under the corresponding selection.

(9)FIREWORK

FIREWORK setting: rotate the right knob to select "DIM", "SPD" (Range: 1-100) or "DECAY" (Range: 1-100), then rotate the left knob to set the parameter under the corresponding selection.

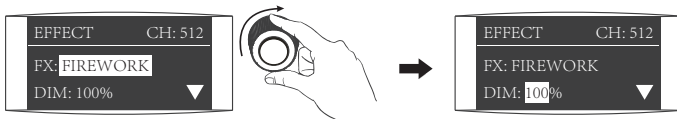

Rotate the right knob to select the "DIM", "SPD" or "DECAY".



Rotate the left knob to set the parameter under the corresponding selection.

(10)EXPLOSION

EXPLOSION setting: rotate the right knob to select "DIM", "SPD" (Range: 1-100) or "DECAY" (Range: 1-100), then rotate the left knob to set the parameter under the corresponding selection.



Rotate the right knob to select the "DIM", "SPD" or "DECAY".



Rotate the left knob to set the parameter under the corresponding selection.

(11)WELDING

WELDING setting: rotate the right knob to select "DIM", "SPD" (Range : 1-100) or "PAUSE" (ON/OFF), then rotate the left knob to set the parameter under the corresponding selection, the light is off at PAUSE ON setting.

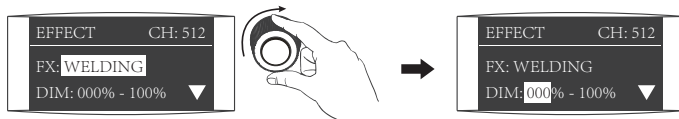

Rotate the right knob to select the "DIM", "SPD" or "PAUSE".

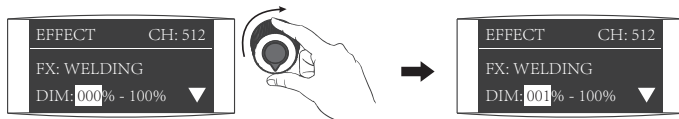

Rotate the left knob to set the parameter under the corresponding selection.

- Lighting effects and additional function might be upgraded with future firmware releases, please check out our website: www.nanlite.com for details.

④MENU:



Press "MODE" to select "MENU".

(1)Channel setting, refer to P6 for address code setting.

(2)LANGUAGE



Rotate the right knob to select "LANGUAGE".



Rotate the left knob to select "ENG" or "中文".

(3)Please refer to P7 for DMX mode setting.

(4)Please refer to P10 for wireless protocol setting.

(5)BLUETOOTH



Rotate the right knob to select "BT".



Rotate the left knob to enter bluetooth reset interface.

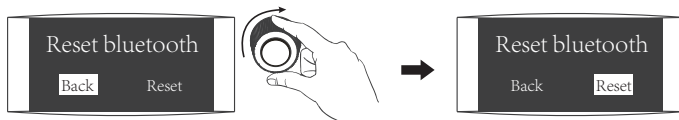

Rotate the right knob to select "RESET".



Press "MODE" to return to "MENU".

(6)FAN

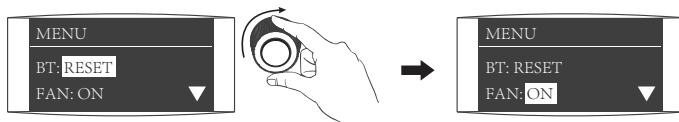

Rotate the right knob to select "FAN".



Rotate the left knob to select "ON" or "OFF".

Note: · The light output is in 100% when the fan is turned on.

· The light output is in 25% when the fan is turned off.

(7)VERSION

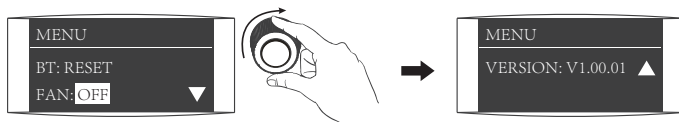

Rotate the right knob to check VERSION.

- ⑤ LOCK or UNLOCK: Long press the right knob to lock all buttons and knobs to prevent an accidental change of current settings, long press the right knob again to unlock all buttons and knobs.



Long press the right knob to lock the current settings.

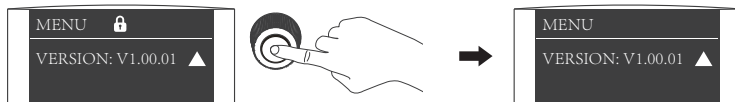

Long press the right knob again to unlock.

2. Switch off the fixture when it is not in use.







Safety Precautions

1. Please open the package to check for possible damage caused in transit, please do not use if damage is found and contact place of purchase or manufacturer as soon as possible.
2. Do not use a power cord with damaged insulation, do not unplug too hard or drag the power cord directly.
3. Make sure that the power supply voltage used matches the voltage designated by the light before installation.
4. Please turn the light off when it is not in use or before cleaning it,
5. Keep the light safely stored and away from children.

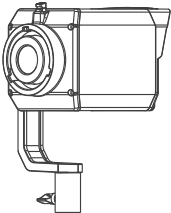
Notice

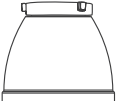
1. Please remove the COB protective cap on the fixture before using.
2. When the light is on do not look directly at the emitter.
3. When the fixture is powered by a battery grip, please use 14.4V-26V/10A V-mount batteries.
4. Do not place objects on the light emitter or allow liquid to flow inside the fixture or the emitter.
5. Do not place the fixture near flammable substances like alcohol or gasoline.
6. When cleaning the light, please wipe off debris or dirt by using a cloth with clean water or neutral cleanser.
7. The fixture should be mounted in dry and ventilated place and avoid being used in damp, dusty or overheated environment, also make sure the fan and the vents are not blocked or obstructed.
8. Any attempt to repair the fixture by yourself will void warranty, disassembling and repair can only be allowed when trained professionals are involved under strict protocol regulated in this manual.
9. For optimal cooling of the fixture, the vents should not be covered when using, or might result in damaging the equipment. The temperature on the fixture surface is high when using for a long time, please caution to prevent burns and scalds.

What's in the box? Please kindly check.

<p>Forza 150 × 1</p>	<p>Power Adapter × 1</p>	<p>Power Cable 4.5M × 1</p>	<p>Reflector × 1</p>
			
<p>Carrying Bag × 1</p>	<p>Bowens Adapter × 1</p>	<p>DMX Reference Guide × 1</p>	<p>User Manual × 1</p>
			

General Fault Detection and Diagnosis

Fault Detection	Diagnosis
The light won't start up.	<ol style="list-style-type: none"> 1. Please check whether there is loose connection between the power adapter and the power cable or the power adapter and the outlet. 2. Please check whether the voltage of power adapter is within designated range. 3. Please check if the battery is installed properly when using an external battery, and if the voltage/current of battery is within designated range.
The fixture can run, but can't be controlled.	<ol style="list-style-type: none"> 1. Please check if the address code is properly set. 2. Please check if the DMX connection cable is connected properly for DMX control solution.
OELD display is on but no light output.	COB or main board might be damaged.
The built-in fan fails to rotate.	Please check if the fan is in the "off" setting.
If the above faults can not be fixed after troubleshooting, please contact distributors or manufacturer for repair.	

This manual and all data within it were produced under controlled conditions, and are accurate at time of print. Any future changes to design/technical data can be found at www.nanlite.com.

Version: V2 2021-09-06

NANLITE

 +86-754-85751187

 +86-754-85300887

 service@nanlite.com

 Zhanglin,324,Dongli Chenghai Shantou Guangdong China

www.nanlite.com